

# Using the loan service

---

## Introduction

The material listed in this catalogue is available for free loan to Island schools. It comprises fossils, artefacts from the past (from prehistory to the 20<sup>th</sup> century), replicas, and models. Although some of the material is boxed or displayed in portable showcases, most of the objects in the collection are intended to be handled in the classroom. Each loan is numbered: the letter B following the number indicates a showcase rather than a collection of handling material. Most of the boxes have notes which provide information on the object (s) and ideas for their use in the classroom.

## The catalogue

The loans have been listed in this catalogue in chronological sections from fossils to the 20<sup>th</sup> century. This arrangement makes it relatively easy to find what is relevant to most National Curriculum history topics. However, the loans are appropriate for use across the whole curriculum.

## Applying for loans

Telephone the museum (523112) with a list of your requests, or email [hes@iow.gov.uk](mailto:hes@iow.gov.uk). The museum will let you know in advance what loans have been allocated to you and when to expect them in school. They will be delivered by County Transport on a Monday. Please check the numbers of the cases and boxes delivered against the delivery note which accompanies them, and let the museum know if there are any discrepancies.

## Returning loans

Loans are usually booked to a teacher in a school for two and a half weeks. If you need the loans for an extended period, please telephone the museum and ask at least two days before they are due for return. We will arrange an extension provided they have not been booked by another school.

When they are due for return, the loans will be collected by us on a Thursday morning. **Please have them ready at the beginning of the day in a convenient place, with the items safely packed and checked against the contents lists. This is important: drivers don't have time to wait while boxes are packed, and loans packed in a hurry are often packed insecurely.**

**The boxes and cases are returned to the museum early on Friday morning, where they are checked and repaired if necessary. Then the loans required for the Monday's delivery to schools are prepared and labelled ready for their collection by us.**

## Accidents

If anything is damaged or lost, please let us know at once so that we can try to arrange repair or replacement, or if necessary withdrawal from circulation. Re-pack broken objects carefully; for example, wrap fragments of glass or pottery in tissue paper.

## Using the Loan Service

Fossils	1 - 2
Prehistory	3
Egyptians	4
Greeks	5
Romans	6 - 9
Saxons & Vikings	10
Middle Ages	11 - 12
Tudors & Stuarts	13 - 14
Georgians & early 19th century	15
Victorians	16 - 26
20th Century	27 - 29
Miscellaneous	30 - 32

## 0-228A FOSSIL COLLECTION ☺

Ammonites  
Sea urchins  
Lamellibranch  
Brachiopod  
Gastropod  
Limestone  
Notes

## 0-232A FOSSIL COLLECTION ☺

Fossilised wood  
Ammonites  
Sea urchin  
Lamellibranch  
Horse's tooth  
Gastropod  
'False fossil': mineral stain  
on flint  
Notes

## 0-245A FOSSIL COLLECTION ☺

Gastropods  
Jet  
Wood  
Scaphopod  
Coral  
Trilobite  
Nut  
Shark's tooth  
Sea urchin  
Notes

## 0-258A FOSSIL COLLECTION ☺

Ammonites  
Limestone pebble  
Gryphaea  
Shark's tooth  
Fish  
Sea urchin  
Fragment of turtle plate  
Plant impressions  
Wood fragment  
Gastropods  
Trilobite  
Notes

## 0-235A FOSSILISATION ☺

Fragment of turtle plate  
Gastropods  
Bivalve shell  
Sea urchin  
Ammonites  
Fern  
Notes

## 0-244A FOSSILISATION ☺

Ammonite cut to show  
internal features  
Ammonite (reproduction)  
Fragment of turtle plate  
Trilobite  
Nut  
Leaf impressions  
Shark's tooth  
Gastropods  
Fish  
Wood  
Sea urchin  
Notes

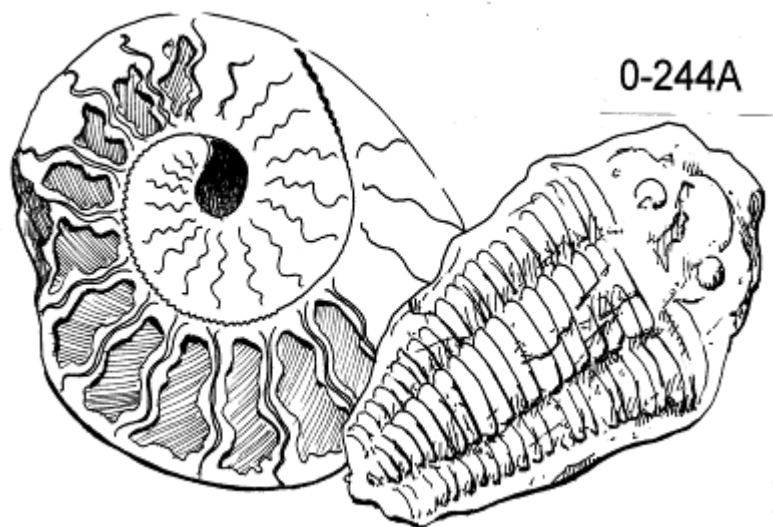

# Fossils

---

## 0-234A AMMONITES ☺

Ammonites: different sizes and features  
Notes

## 0-242A AMMONITES

Ammonites: different sizes and features  
Ammonite cut to show internal features  
Notes

## 0-243A AMMONITES ☺

Ammonites  
Ammonite cut to show internal features  
Notes

## 0-229A FOSSIL SEA URCHINS ☺

Seven examples, varying sizes and condition  
Notes

## 0-13A FOSSIL DINOSAUR BONES ☺

Four fossil bones of iguanodon  
Illustrations

## 0-233A FOSSIL ELEPHANT'S TOOTH ☺

Fossilised tooth  
Notes

## 0-236A FOSSIL ELEPHANT'S TOOTH ☺

Fossilised tooth  
Notes

## 0-241A PLANT FOSSILS

30 small plant fossils  
(Carboniferous)  
Notes

## 0-231A MINERALS

Fluorspar  
Calcite  
Marcasite  
Malachite  
Iron pyrites  
Quartz  
Gallena  
Notes

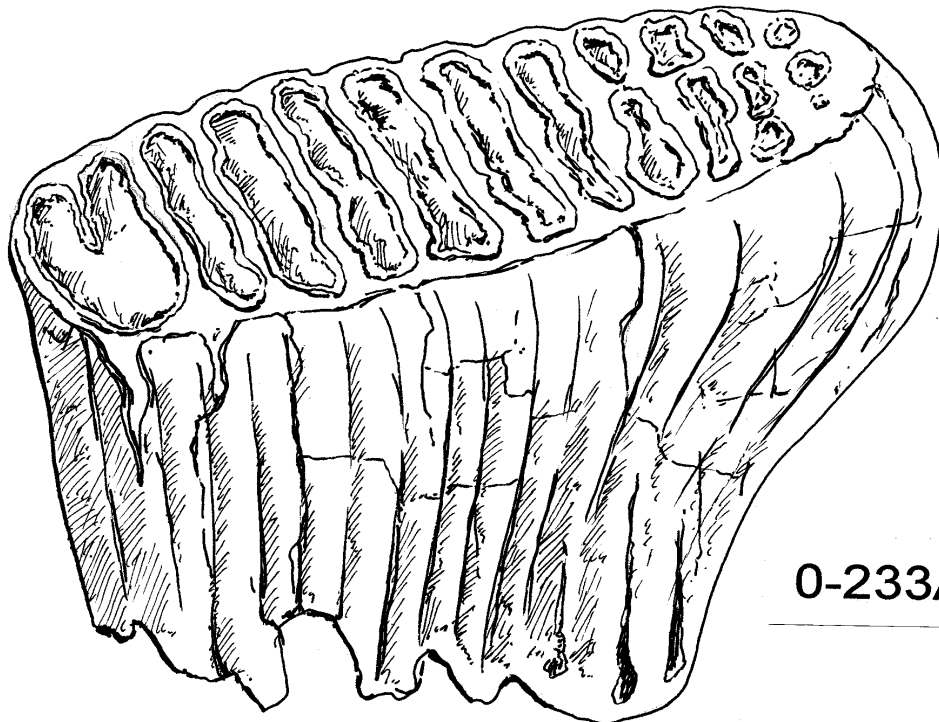

0-233A

## 1-100A FLINT IMPLEMENTS

Flint flake  
Hammer-stone  
Core  
Hand-axe  
Tranchet axe-head  
Polished axe-head  
Tranchet arrowhead  
Leaf-shaped arrowhead  
Microlith  
Scrapers  
Knife  
Borer  
Notes and illustrations

## 1-101A IW FLINT IMPLEMENTS

A 17 flint implements found on the Isle of Wight with ID sheets  
24 Flint tools to sort and identify  
Flint core showing scars where blades have been removed  
3 Replica hafted axes  
Book: Nature and subsequent uses of flint  
Video: Grimes Grave

## 1-02A DAILY LIFE IN THE NEOLITHIC

Replica pot (based on one found in Orkney)  
Antler bead  
Bone needle  
4 sherds of treated pottery  
Replica spindle and antler whorl strung with flax  
Piece of linen cloth made from Handspun flax dyed with sloe  
Slippers made by the ancient Technique of 'nahlebunden'  
Various samples of netting, string and rope made from different natural fibres  
Sample of unspun flax  
Sample of Emmer (ancient wheat)  
Book: Guide book to Skara Brae

## 1-103A OTZI THE MAN IN THE ICE

Action man Otzi

Book: The Man in the Ice by Konrad Spindler  
Replicas of some of Otzi's equipment

## 1-22A THE BRONZE AGE ☺

Bronze axe-head (replica)  
Flint arrowhead  
Flint borer  
Flint knife  
Fragment of large collared urn  
Reproduction of small collared urn  
Notes

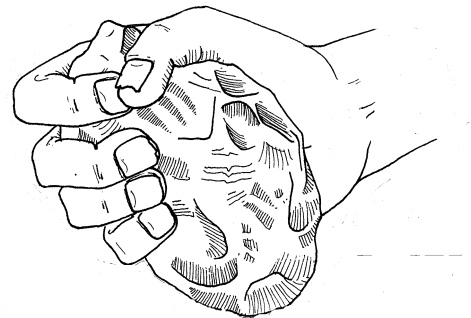

## 1-46A BRONZE AGE AXES

Flat axe (genuine)  
Flanged axe (replica)  
Palstave (replica)  
Socketed axe (replica)  
(These show the development of the axe)  
Two-part mould for an axe-head (replica)

# Egyptians

---

## 11-273C ANCIENT EGYPTIAN MAN

Costume model

## 11-274C ANCIENT EGYPTIAN WOMAN

Costume model

## 11-112A ANCIENT EGYPT: PERSONAL OBJECTS

Bead necklace

Small heart-shaped  
amulet

Small faience pot

Menat (replica)

Ibex cosmetic knife (replica)

Hair curler "

Thimble "

Shell ornament (reproduction)

Bead necklace "

Notes

11-354A

## 11-353A ANCIENT EGYPTIAN POT

Notes

## 11-354A ANCIENT EGYPT: PREPARING FOR THE AFTER-LIFE

Four models showing the process  
of mummification

Two ushabtis

Stone from a pyramid

*Evening Standard* souvenir  
newspaper of the Tutankhamun  
exhibition (Sat. 6 May 1972)

Copy of a fragment of wall-  
painting from a tomb

Ushabti (reproduction)

Heart scarab "

Notes

## 11-355A ANCIENT EGYPT: ANIMALS

Fly amulet

Hippo (reproduction)

Cat goddess "

Hedgehog "

Jerboa "

Notes



**2-128A GREEK POTTERY**

Lekythos  
Oil bottle (replica)  
Scent bottle "  
Notes

**2-293A GREEK POTTERY**

Bottle  
Small jar  
Trinket pot (replica)  
Lamp "  
Notes

**2-294A GREEK POTTERY**

Lekythos  
Small bottle  
Drinking-cup (replica)  
Wine jug "  
Notes

**2-306A GREEK POT**

Lekythos  
Notes

**2-284C GREEK MAN**

Costume model

**2-285C GREEK WOMAN**

Costume model

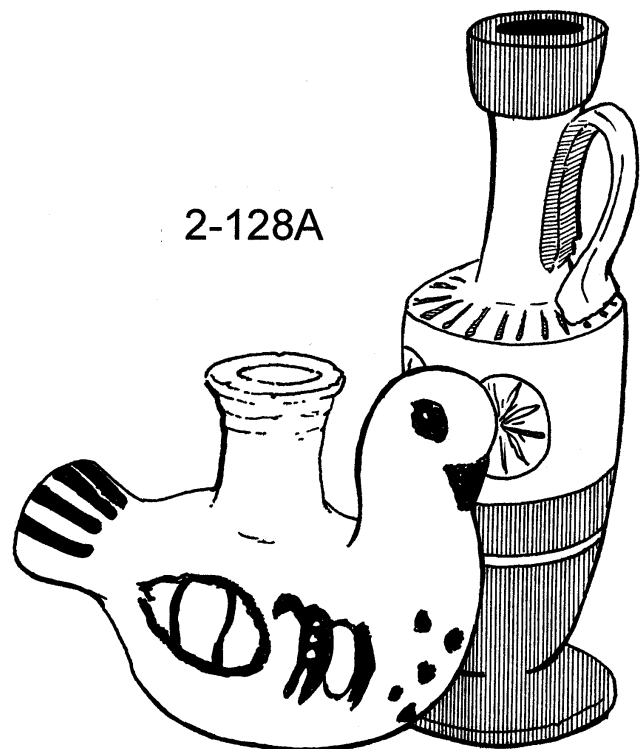

## 2-1A THE ROMANS

Mosaic fragment  
Tesserae  
Nail  
Plaster fragment  
Pottery fragments  
Oyster shell  
Bronze spoon  
Bone hairpin  
Fragment of box flue-tile  
Coin lamp (reproduction)  
Brooch "  
Key "  
Notes "

## 2-12A THE ROMANS

Mosaic fragment  
Tesserae  
Nail  
Plaster fragment  
Pottery fragments  
Oyster shell  
Fragment of box flue-tile  
Coin (reproduction)  
Plaque "  
Brooch "  
Oil lamp "  
Spoon "  
Notes "

## 2-299A ROMAN COLLECTION ☺

Tesserae  
Plaster fragment  
Pottery fragments  
Fragment of box flue-tile  
Oil lamp  
Kitchen waste (bone, tooth, shell)  
Coin  
Glass fragment  
Bracelet  
Brooch (reproduction)  
Coin "  
Notes "

## 2-300A ROMAN COLLECTION ☺

Tesserae  
Plaster fragment  
Oil lamp  
Pottery fragment  
Kitchen waste (bone, tooth, shell, antler)  
Glass fragment  
Spoon (reproduction)  
Brooch "  
Stylus "  
Mouse ornament "  
Coin "  
Oil lamp "  
Notes "

## 2-165A THE ROMANS ☺

Oil lamp  
Mosaic fragment  
Tesserae  
Pottery fragments  
Kitchen waste (bone, tooth, shell)  
Spindle whorl  
Dress pin  
Tweezers  
Samian dish (replica)  
Spoon (reproduction)  
'Dice pot' "  
Medusa pendant "  
Notes "

2-1A

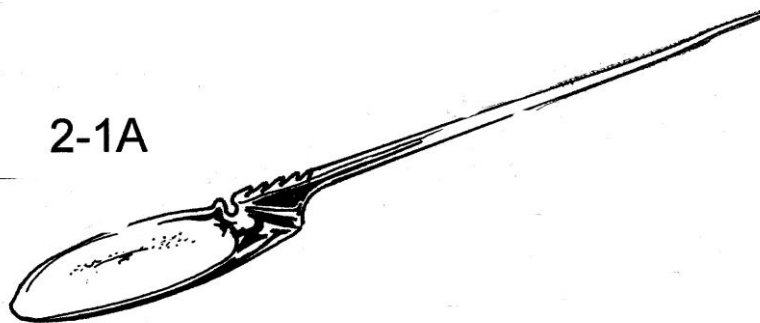





**1-143C CELTIC MAN**  
Costume model

**1-144C CELTIC WOMAN**  
Costume model

**2-147C ROMAN MAN**  
Costume model

**2-148C ROMAN WOMAN**  
Costume model

**2-268C ROMAN MAN**  
Costume model

**2-269C ROMAN WOMAN**  
Costume model

**2-8A TOGA**  
Toga  
Notes & instructions

**2-266A CHILD'S TOGA ☺**  
Toga to fit boy in year 3 or 4  
Notes  
Instructions

**2-267A CHILD'S TOGA ☺**  
Toga to fit boy in year 3 or 4  
Notes  
Instructions

**2-213A ROMAN POTTERY**  
13 assorted pottery fragments  
including rims and bases  
Notes and pictures etc

**2-223A ROMAN POTTERY**  
10 assorted pottery fragments  
including rims and bases  
Notes and pictures etc

**2-252A ROMAN POTTERY**  
14 assorted pottery fragments  
including rims and bases  
Notes and pictures etc

**2-280A SAMIAN POTTERY**  
Replica Samian bowl  
Genuine pottery fragments  
Replica fragments (to piece  
together)  
Coins  
Picture  
Notes

**2-281A ROMAN KITCHEN POTTERY**  
Pottery fragments  
Mortarium (reproduction)  
Notes

**2-395A ROMANO-BRITISH CLOTHING**  
Linen tunic & tie  
Wool tunic & tie  
Scarf  
Cloak (byrrus Britannicus)  
Gallic cloak  
Sandals  
Notes

**2-396A ROMAN MEDICAL EQUIPMENT**  
Cataract needle  
Crown trephine and bow  
Bone lever  
Hook  
Medical spoon  
Probe  
Spoon probe  
Saw  
Scalpel  
Ligula  
Spatul  
Notes

**2-215A OIL LAMPS**

Four genuine pottery oil lamps  
Reproduction oil lamp  
Notes

**2-238A ROMAN OIL LAMPS**

Four genuine pottery oil lamps  
Reproduction oil lamp  
Notes

**2-9A ROMAN LAMP AND WRITING**

**MATERIALS ☺**

Pottery lamp  
Pottery lamp (reproduction)  
Wax-coated wooden writing  
tablet (reproduction)  
Stylus                   "  
Notes

**2-49C CONSTRUCTION OF A  
ROMAN ROAD ☺**

Model showing Roman soldiers in  
process of building a road, on  
base 60 x 45 cm, under  
Perspex

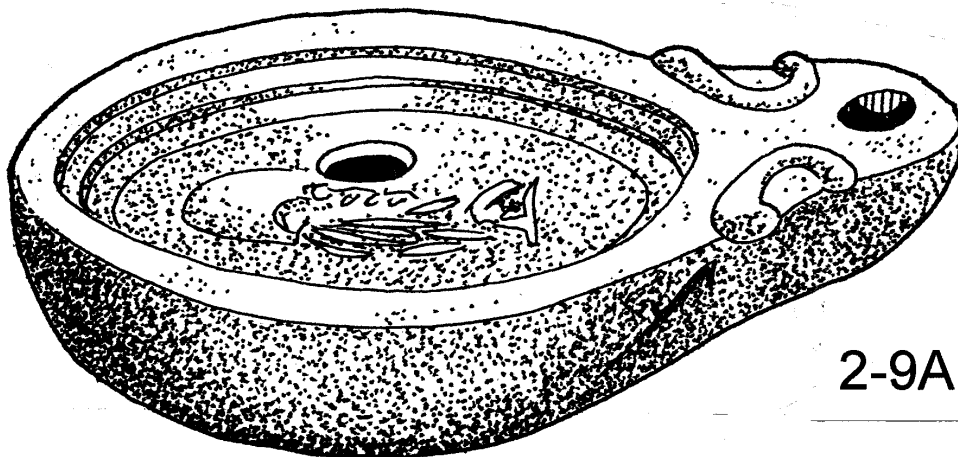

2-9A

# Saxons and Vikings

---

## 3-42A THE ANGLO-SAXONS

Fragment of pottery  
Brooch  
Pot (reproduction)  
Bottle "  
Bowl "  
Lamp "  
Four brooches "  
Double twist ring "  
Two Saxon coins "  
Franks casket "  
Piece of mail (replica)  
Notes



## 3-84C ANGLO-SAXON LORD

Costume model

## 3-85C ANGLO-SAXON LADY

Costume model

## 3-118C ANGLO-SAXON PEASANT MAN

Costume model

## 3-119C ANGLO-SAXON PEASANT WOMAN

Costume model

## 3-261B ANGLO-SAXON BURIAL

Model of Victorian excavation of  
Anglo-Saxon burial  
Notes

## 3-296A ANGLO-SAXON POT

Pot (replica)  
Notes

## 3-371A ANGLO-SAXON POT

Same as 3-296A

## 3-401A ANGLO-SAXONS GAMES - HNEFATAFL

15 leather boards and counters.  
Notes

## 3-402A ANGLO-SAXON GAMES - NINE MEN'S MORRIS

15 leather boards and counters  
Notes

## 3-403A REPLICA IW SAXON SKILLET

Fragment of pottery

## 3-203A VIKING SHIP

Viking ship model

**4-192C NORMAN KNIGHT**  
Costume model

**4-57D THE BAYEUX TAPESTRY**  
Set of 12 slides  
Notes

**4-75A MAIL** ☺  
Mail coif (modern)  
Piece of riveted mail (replica)  
Five arrowheads (replica)  
Picture  
Notes

**4-67C NORMAN LORD**  
Costume model

**4-68C NORMAN LADY**  
Costume model

**4-136C SIEGE TOWER**  
Model  
Notes

**4-137C BATTERING RAM**  
Model  
Notes

**4-138C CAT OR SOW**  
Model  
Notes

**4-139C MANGONEL**  
Model  
Notes

**4-140C TREBUCHET**  
Model  
Notes

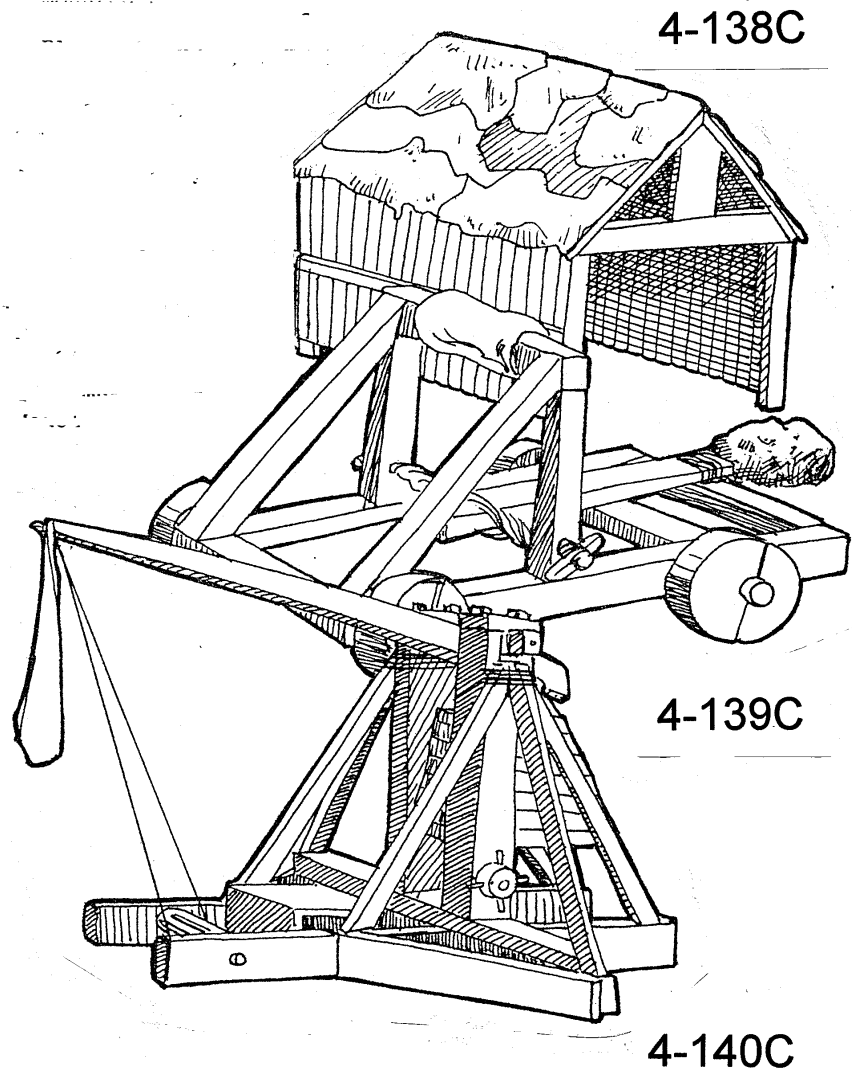

# Middle Ages

---

**4-216C LORD 1300**  
Costume model

**4-217C LADY 1300**  
Costume model

**4-69C 14TH-CENTURY LORD**  
Costume model

**4-70C 14TH-CENTURY LADY**  
Costume model

**4-189C MEDIEVAL MINSTREL**  
Costume model

**4-190C MEDIEVAL MERCHANT**  
Costume model

**4-191C MEDIEVAL MONK**  
Costume model

**4-55C MEDIEVAL PEASANT WOMAN**  
Costume model

**4-56C MEDIEVAL PEASANT MAN**  
Costume model

**4-18D COUNTRY LIFE IN THE  
MIDDLE AGES**  
Set of 12 slides of pictures from  
medieval manuscripts  
Notes

**4-19D COUNTRY LIFE IN THE  
MIDDLE AGES**  
Set of 36 slides of pictures from  
medieval manuscripts  
Notes

**4-276A MEDIEVAL JUGS**  
13th-century wine jug (replica)  
Puzzle jug (replica)  
Notes

**4-295A MEDIEVAL JUG**  
Baluster jug (replica)  
Notes

**4-298A AQUAMANILE**  
Aquamanile (replica of jug in form of  
knight on horseback)  
Notes

**4-221A ALEMBIC**  
Vessel for purifying water (replica)  
Notes

**4-277A MEDIEVAL TILES**  
13th-century tile (incomplete)  
Four patterned tiles (reproduction)  
Notes

**4-356A MEDIEVAL LIFE ☺**  
Part of roof-tile  
Fragment of cooking-pot  
Candle holder (reproduction)  
Thimble                   "  
Four coins               "  
Bracelet                 "  
Key                        "  
Spoon                    "

**4-390A MEDIEVAL LANTERNS**  
15<sup>th</sup> C. Tankard lantern (repro)  
14<sup>th</sup> C. Lantern (replica of  
lantern in Mus. of London)

**6-239A LANTERN AND JUG ☺**

Horn lantern (replica)  
 Blackjack           "  
 Notes

**6-264A CANDLE-HOLDERS**

Wrought-iron candelabrum  
 Wrought-iron floor standard  
 Notes

**5-330A TUDOR TOYS ☺**

Cup and ball (reproduction)  
 Lenten rattle           "  
 Whip and top"  
 Two streamers           "  
 String-driven mill       "  
 Five stones           "  
 Notes

**5-337A TUDORS: HOME LIFE ☺**

Inkwell (replica)  
 Pounce pot           "  
 Quill pen           "  
 Oil lamp           "  
 Pipkin           "  
 Jug           "  
 Watering pot       "  
 Notes

**6-301A PEWTERWARE ☺**

Pewter plate (reproduction)  
 Spoon           "  
 Candlestick       "  
 Notes

**6-41A 17TH-CENTURY LIFE ☺**

Bellarmino jug  
 Four buttons  
 Drawer handle  
 Piece of embroidered bed-  
   hanging ca. 1670  
 Pot (incomplete)  
 Charles II's seal (replica)  
 Notes

**5-368A TUDOR LIGHTING**

Oil lamp (reproduction)  
 Pottery candlestick "  
 Rushlight holder & candlestick "  
 Notes

**5-361A TUDOR MEALS:**

**PREPARATION AND SERVING ☺**

Fragment of dish  
 Wooden trencher (replica)  
 Pipkin           "  
 Spoon           "  
 Horn beaker       "  
 Wooden bowl       "  
 Jug           "  
 Pottery beaker     "  
 Notes

**5-369A TUDORS: ITEMS FOR THE RICH**

Bronze buckle  
 Elizabeth I sovereign (repro)  
 Money box           "  
 Four coins           "  
 Thimble           "  
 Pomander           "  
 Scent bottle       "  
 Pattens           "  
 Horn book           "  
 Quill pen           (replica)  
 Picture (master & schoolboy)  
 Notes

**5-373A SALT GLAZED POTTERY**

Fragment of Bellarmine jug  
 Bellarmine jug (reproduction)  
 Tankard           "  
 Notes



# Tudors and Stuarts

---

## 6-37A CIVIL WAR WEAPONS

Basket-hilted broadsword  
(reproduction)

Rapier "

Notes

## 6-23A(1&2) CIVIL WAR HELMETS ☺

Lobster-tail helmet (reproduction)

Pikeman's helmet "

Pictures

Notes

## 6-290A BOY'S COSTUME 1640s ☺

Complete reproduction middle-  
class outfit for year 5 boy

Notes

## 6-291A GIRL'S COSTUME 1640s ☺

Complete reproduction middle-  
class outfit for year 5 girl

Notes

## 5-120C FASHION 1500 (MAN)

Costume model

## 5-121C FASHION 1500 (WOMAN)

Costume model

## 5-169C FASHION 1545 (MAN)

Costume model

## 5-170C FASHION 1545 (WOMAN)

Costume model

## 5-82C FASHION 1588 (MAN)

Costume model

## 5-83C FASHION 1588 (WOMAN)

Costume model

## 5-145C TUDOR PEASANT (MAN)

Costume model

## 5-146C TUDOR PEASANT (WOMAN)

Costume model

## 5-131C WATER CARRIER 1540

Costume model

## 6-61C CAVALIER

Costume model

## 6-76C FASHION 1640 (WOMAN)

Costume model

## 6-59C PURITAN MAN

Costume model

## 6-60C PURITAN WOMAN

Costume model

## 6-198C CIVIL WAR MUSKETEER

Costume model

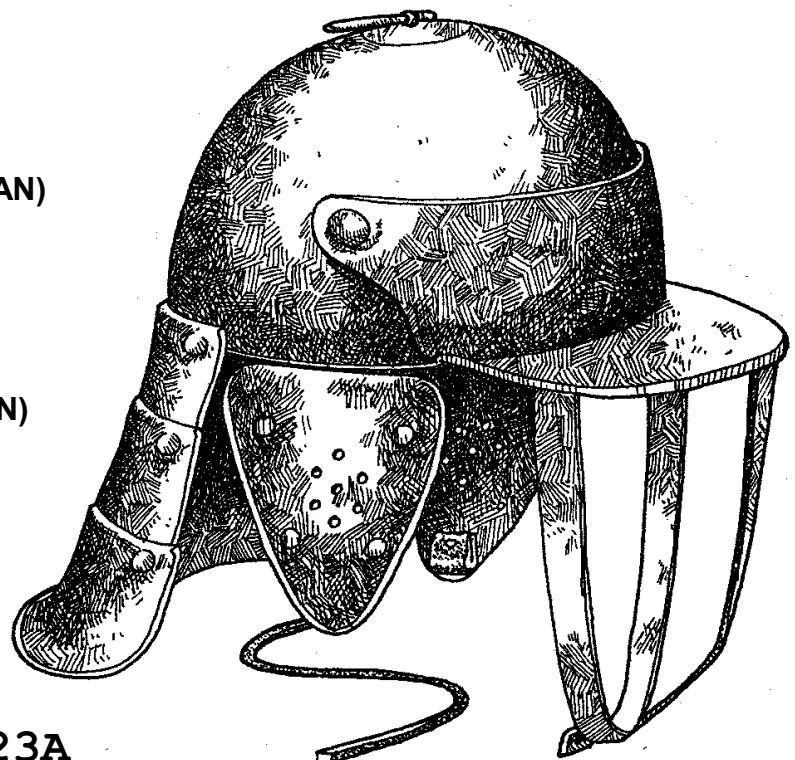

6-23A



---

## 18th and early 19th centuries

### 7-78C FASHION 1750 (MAN)

Costume model

### 7-79C FASHION 1750 (WOMAN)

Costume model

### 8-168B REGENCY COSTUME

Pink silk brocade spencer

Pair of indoor shoes

Notes

### 8-133C FASHION 1825 (MAN)

Costume model

### 8-134C FASHION 1825 (WOMAN)

Costume model

### 7-132C 'BLUE JENNY' 1760

Costume model

### 78-63A LIGHTING:

18TH & 19TH CENTURIES ☺

Rushlight holder

Candle holder & tinder box

Candle holder

Candle mould

Notes

### 8-202C SAILOR (NAPOLEONIC WARS)

Costume model

### 7-256A SMUGGLING ☺

Brandy keg

Grappling hook

Notes

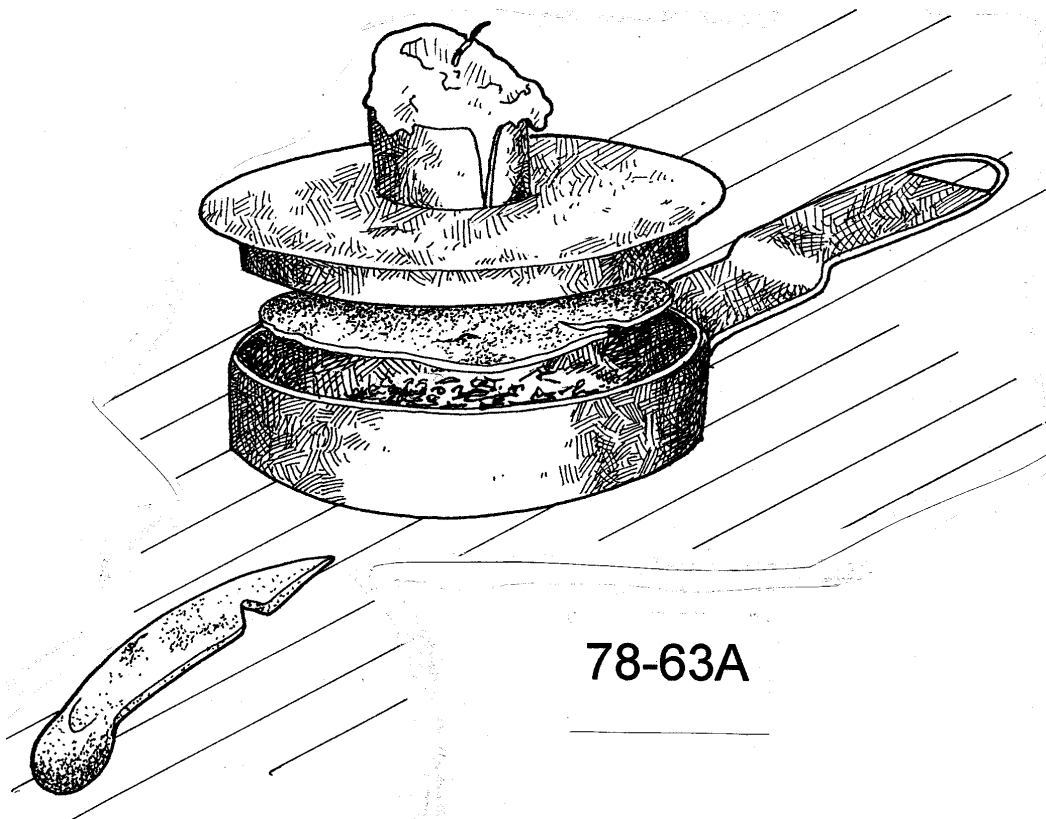

78-63A

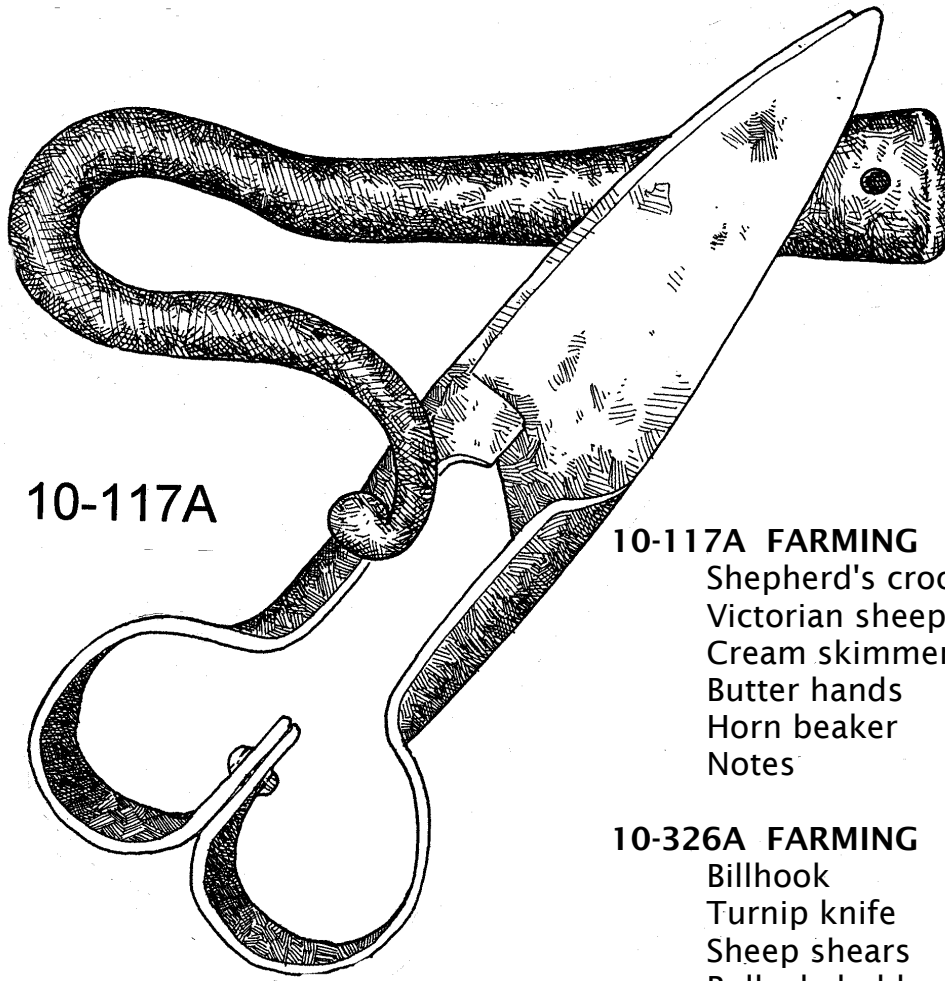

10-117A

**10-117A FARMING**  
Shepherd's crook  
Victorian sheep shears  
Cream skimmer  
Butter hands  
Horn beaker  
Notes

**10-326A FARMING**  
Billhook  
Turnip knife  
Sheep shears  
Bullock- holder  
Bird- scarer  
Notes

**8-135C LONGSHOREMAN**  
Costume model

**8-26C AGRICULTURAL LABOURER**  
Costume model

**10-260A FARMING**  
Billhook  
Sheep shears  
Animal- feed scoop  
Notes

**8-27C MILKMAID**  
Costume model

**8-211A YOKE ☺**  
Yoke for carrying buckets

**10-327A THE DAIRY**  
Skimmer  
Scotch hands  
Butter stamp  
Milk measure  
Notes

**8-178A STABLE LANTERN ☺**  
Stable lantern  
Notes

**8-303A COSTREL ☺**  
Costrel (drinking flask)  
Notes

**8-102A ROASTING JACK**

Bottle- jack for roasting  
Key  
Notes and instructions

**8-105A ROASTING JACK**

Bottle- jack for roasting  
Key  
Notes and instructions

**8-174A GRID IRON ☺**

Grid- iron with drip trough  
Notes

**8-90A SAUCEPANS ☺**

Early- 19th- century tinker- made  
copper saucepan  
Late- 19th- century bell- metal  
saucepan  
Notes

**8-92A SKILLET ☺**

Iron skillet pan with handle for  
hanging over fire  
Notes

**89-352A COPPER KETTLE ☺**

**8-127A KITCHEN EQUIPMENT ☺**

Bread mould  
Cake mould  
Patty tins  
Pastry cutter  
Pastry wheel  
Sugar nippers  
Tin opener  
Notes

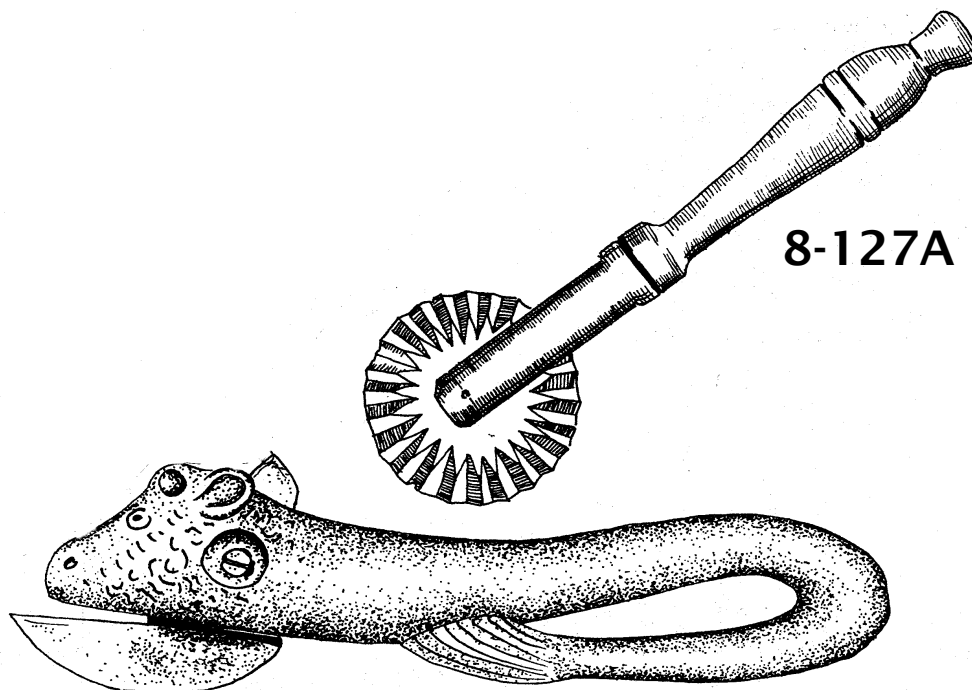

8-127A

**8-89A VICTORIAN KITCHEN EQUIPMENT ☺**

Copper jelly mould (1840)  
Two china moulds  
Rolling pin  
Mrs Beeton's Book of Household Management (facsimile)

**8-107A FOOD CHOPPER ☺**

Food chopper  
Attachments  
Notes

**8-237A FOOD CHOPPER ☺**

Food chopper (mincer)  
Notes

**8-187A FOOD CHOPPER ☺**

'New Standard' food chopper made in USA (improved version of 8- 107A)  
Notes

**8-312A SAUSAGE-MAKING MACHINE**

Sausage- making machine ☺  
Notes

**8-314A COFFEE MILL ☺**

Coffee mill  
Notes

**8-32A CAKE-MIXER (1896) ☺**

Tin  
Clamp  
Mixing mechanism  
Notes

**8-160A MARMALADE CUTTER ☺**

Marmalade cutter  
Notes

**8-188A KITCHEN EQUIPMENT ☺**

Gingerbread mould  
Nutmeg grater  
Notes

**8-179A KNIFE CLEANER**

Rotary knife cleaner  
Notes

**8-248A VICTORIAN WALL TILES**

Two transfer- printed wall tiles  
Three embossed wall tiles  
Notes

**8-24C MUFFIN MAN**

Costume model

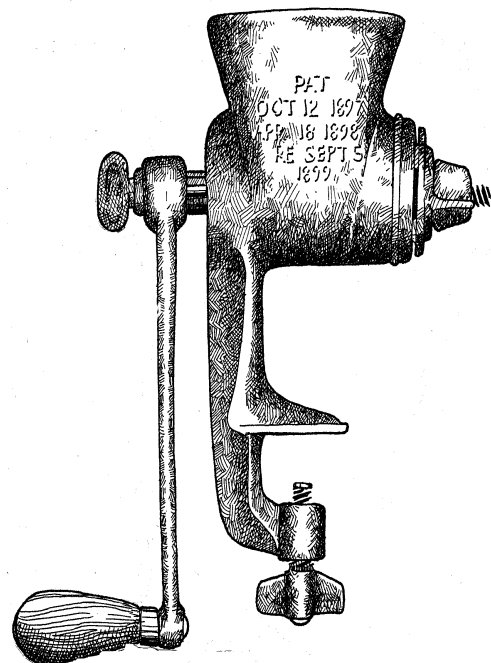

8-107A

**8-28C PARLOURMAID**

Costume model

**78-63A LIGHTING:**

**18TH & 19TH CENTURIES ☺**

Candle holder & tinder box

Candle snuffer

Candle mould

Rushlight holder (replica)

Notes

**8-302A LIGHTING**

Candle holder

Candle mould

Candle snuffer

Notes

**8-335A BULL'S EYE LANTERN**

Bull's eye lantern

Notes

**8-207A LIGHTING: OIL LAMPS**

Crusie lamp

Tin- miner's oil lamp

Wick trimmer

Match holder

Notes

**8-104A FOOT WARMER ☺**

Notes

**8-289A FOOT WARMER ☺**

Notes

**8-181A HOT WATER CAN**

Notes

**8-333A HOT WATER CAN**

Notes

**8-64C FASHION 1860 (MAN)**

Costume model

**8-65C FASHION 1860 (WOMAN)**

Costume model

**8-80C FASHION 1875 (MAN)**

Costume model

**8-81C FASHION 1875 (WOMAN)**

Costume model

**8-305A VICTORIAN DRESS**

Victorian dress from 1860s

Notes

**8-310A VICTORIAN CRINOLINE  
GOWN (reproduction)**

Chemise

Camisole

Drawers

Crinoline

Petticoat

Gown

Notes

**8-227A VICTORIAN GARMENTS**

Lady's cotton blouse

Lady's velvet bodice

Man's waistcoat

Notes

**8-108A BUSTLE DRESS**

Countrywoman's bustle dress  
(reproduction)

Notes

**8-177A VICTORIAN UNDERWEAR**

Chemise

Corset

Camisole

Drawers

Combinations

Flannel bodice

Silk petticoat

Flannel petticoat

Nightdress

Nightcap

Feature from The Girl's Own  
Paper, 1899 (photocopy)

Notes

**8-101A VICTORIAN UNDERWEAR**

Silk petticoat

Flannel petticoat

Drawers

Pair of combinations

Nightdress

Feature from The Girl's Own  
Paper, 1899, (photocopy)

Notes

**89-176A CHILDREN'S CLOTHES ☺**

Cotton dress

Silk dress

Drawers

Boy's shirt

Girl's pinafore (reproduction)

Notes

**8-106A VICTORIAN BABIES'  
CLOTHES ☺**

Two gowns

Petticoat

Bonnet

Flannel bodice

Shirt

Carrying- cloak

Notes

**8-182B VICTORIAN ACCESSORIES ☺**

Chenille cloak  
Lace collar  
Mittens  
Evening slippers  
Velvet bonnet

**8-95B VICTORIAN ACCESSORIES ☺**

White kid evening gloves  
White lace and ivory fan  
Tortoise- shell comb  
Hat pins  
Tapestry bag  
Bead purse  
Black lace scarf

**8-73A VICTORIAN PERSONAL  
OBJECTS ☺**

Ostrich- feather fan  
Jet decoration  
Beaded drawstring bag  
Leather purse  
Stocking purse  
Pince- nez  
Magnifier  
Button hook  
Skirt lifter  
Rouge pot  
Chatelaine pencil  
Lady's watch  
Watch- chain  
Watch- chain ornament  
Vesta (match- box)  
Notes

**8-125B PERSONAL ITEMS  
(VICTORIAN & EDWARDIAN)**

Hair curlers  
Fan  
Cut- throat razor  
Amber cigar- holder with case  
A 'lady's companion'  
Handbag  
Sovereign purse  
Pair of tortoise- shell- rimmed  
spectacles with case  
Stylograph  
Notes

**8-113A BOOT AND GLOVE  
ACCESSORIES ☺**

Boot jack  
Boot hook  
Button hook  
Shoe trees  
Glove stretcher  
Notes

**8-212A SHOE AND GLOVE  
ACCESSORIES ☺**

Pair of shoe trees  
Button hook  
Glove stretchers  
Notes

**8-175A HAT STRETCHER**

**8-161A SEWING MACHINE ☺**

Small Victorian sewing machine  
Notes

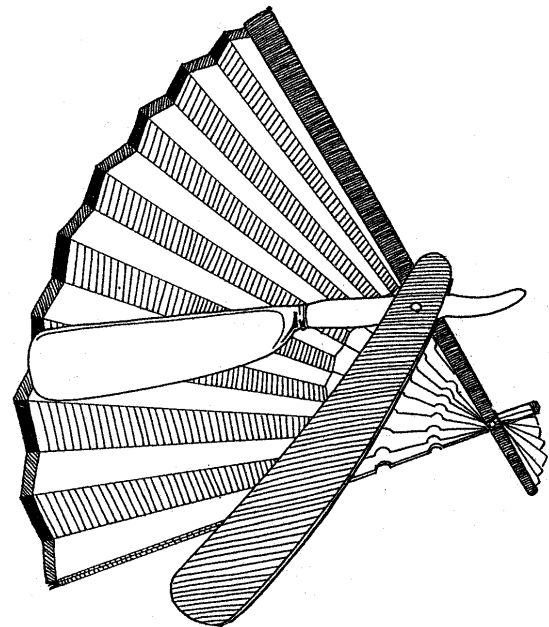

**8-125B**

**8-200C VICTORIAN WASHERWOMAN**

Costume model

**89-33A WASH-DAY ☺**

Soap- grater  
Wash- dolly  
Posser  
Wash- boards  
Tongs  
Clothes- pegs  
Notes

**89-311A WASH-DAY ☺**

Soap- grater  
Wash- dolly  
Posser  
Wash- board  
Tongs  
Clothes- pegs  
Notes

**89-331A WASH-DAY ☺**

Wash- board  
Wash- dolly  
Baby posser  
Wash- tongs  
Clothes- pegs  
Notes

**8-99A IRONS ☺**

Flat- iron  
Stand  
Charcoal iron  
Notes

**8-98A IRONS ☺**

Charcoal iron  
Box- iron with slug  
Notes

**8-111A IRONS ☺**

Italian iron  
Gauffering iron  
Polishing iron  
Miniature flat- iron and stand  
Notes

**8-153A IRONS ☺**

Italian iron with rod  
Box- iron with iron slug  
Iron with bar cavity  
Notes

**8-167A GOOSE IRON ☺**

Iron used by tailors  
Notes

**89-362A IRONS ☺**

Spirit iron  
Electric iron  
Notes

**8-363A IRONS ☺**

Sad iron  
Box- iron  
Small flat- iron  
Notes

**8-364A IRONS: MRS POTTS'S IRONS ☺**

Mrs Potts's box- iron  
Mrs Potts's iron: detachable  
handle & base  
Mrs Potts's iron: base  
Notes

**8-365A IRONS ☺**

**(for special purposes)**  
Three hatter's irons  
Polishing iron  
Fluting iron  
Italian iron  
Notes

**8-366A CHARCOAL IRONS ☺**

Large charcoal iron with chimney  
Small charcoal iron  
Notes



**8-151C TENNIS PLAYER 1870**  
Costume model

**8-152C CRICKETER 1840**  
Costume model

**8-171C VICTORIAN SWIMMING  
COSTUME**  
Costume model

**8-149C CYCLIST 1890 (MAN)**  
Costume model

**8-150C CYCLIST 1895 (WOMAN)**  
Costume model

**8-201C VICTORIAN BOBBY**  
Costume model

**8-11A LAW AND ORDER ☺**  
Truncheon  
Policeman's lamp  
Handcuffs  
Knuckleduster

**8-25C RAILWAY NAVVY**  
Costume model

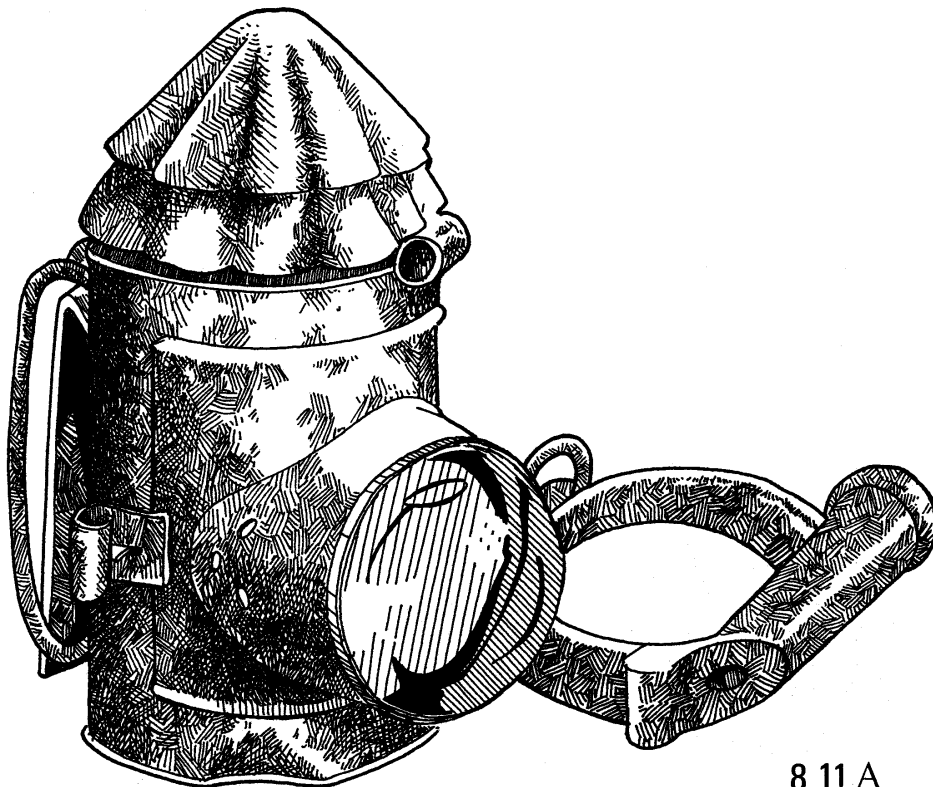

8.11 A

## 8-186A VICTORIAN TOYS & GAMES ☺

Doll (mid-19th-century)  
 Gyrograph  
 Tops  
 Diabolo  
 Wooden soldier  
 Maze  
 Board game  
 Jumping Jack  
 Notes

## 8-184A VICTORIAN EDUCATIONAL GAMES ☺

Alphabet frieze (1883)  
 Animal alphabet game  
 Slate  
 British Sovereigns Game  
 Ivory letters  
 History card game  
 Cross-stitch sampler  
 Bone letters of the alphabet  
 Dick Whittington play  
 Reading, story & music books  
 Notes

## 8-126A(1,2,3) VICTORIAN TOY CIRUCS ☺

14 jointed wooden animals  
 Circus equipment

## 8-66B VICTORIAN JIG-SAW PUZZLE

Jig-saw puzzle 'The Great Exhibition' displayed under Perspex on panel  
 37 cm x 30 cm

## 8-225A STEREOSCOPIC VIEWER

Stereoscopic viewer  
 Three cards (l.w. views)  
 Notes

## 8-275A ZOETROPE ☺

Zoetrope (small reproduction)  
 Picture strips  
 Notes

## 8-173A ALPHABET BLOCKS

Wood blocks each with a letter and appropriate illustration (20)

## 8-321A HOOP (child's reproduction)

## 8-322A HOOP (child's) "

## 10-319A TRADITIONAL TOYS & GAMES

Whip and top (reproduction)  
 Cup & ball game "  
 Spinning top "  
 Diabolo "  
 Notes

## 10-214A TRADITIONAL TOYS & GAMES

Diabolo (reproduction)  
 Cup and ball "  
 Spinning top "  
 Whip and top "  
 Notes

8-126A

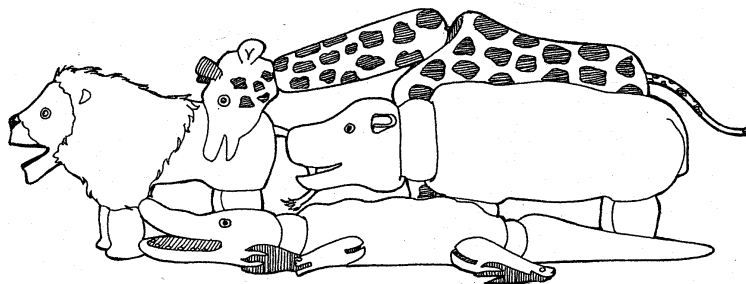

**8-71B SAMPLER (1856)**

Sampler displayed under perspex  
on panel 36 cm x 32 cm

**8-220A SET OF SLATES**

30 slates (for class use)  
Slate pencils

**8-288A SET OF SLATES**

30 slates (for class use)  
Slate pencils

**8-270A ABACUS**

School abacus (on stand)

**8-271A ABACUS**

School abacus (on stand)

**8-272A ABACUS**

School abacus (stand missing)

**8-309A WRITING ☺**

Pewter inkwell  
Quill pen  
Notepaper  
Notes

**8-205A WRITING ☺**

Sheet of Victorian notepaper  
Envelope, dated 1836  
Quill pen (modern)  
Steel-nib pen with wooden holder  
Pen-knife  
Ruler  
Letter scales  
Stamp box  
Letter opener with seal in handle  
Notes

**8-206A WRITING ☺**

Victorian inkstand with stag's head decoration  
Queen Victoria marble paper-weight  
Brown stoneware ink bottle

**8-240A STAPLER ☺**

19th-century stapler  
Notes

**8-199C VICTORIAN POSTMAN**

Costume model

**8-257A SCRIBE'S CASE ☺**

Brass case for pens and ink  
(from Far East)  
Notes

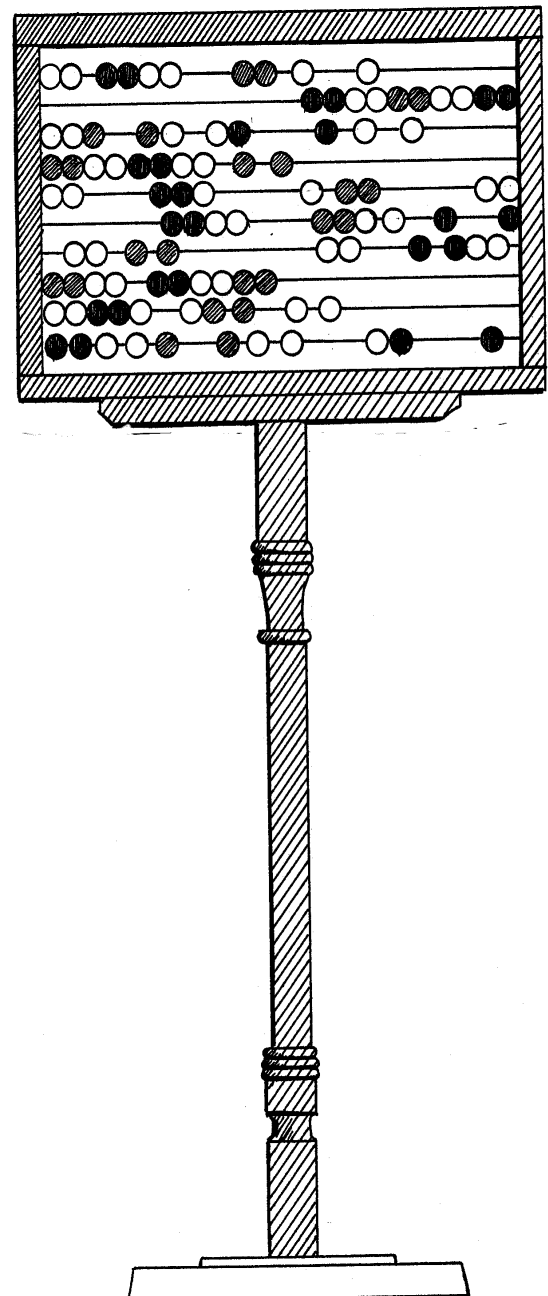

# Victorians

---

## 8-219A VICTORIAN MISCELLANY ☺

Glove stretcher  
Scotch hands  
Powder box  
Sugar nippers  
Inhaler  
Moustache curler  
Mourning handkerchief  
Tin- opener  
Button hook  
Notes

## 8-286A VICTORIAN MYSTERY OBJECTS ☺

Glove stretcher  
Bath thermometer  
Ruler  
Hand cooler  
Button hook  
Egg topper  
Skirt lifter  
Notes

## 8-376A FLORENCE NIGHTINGALE

Turkish lantern (reproduction)  
Scutari brassard "  
Notes

## 8-400A VICTORIAN/EDWARDIAN BOTTLES & JARS

2 stoneware jars  
5 stoneware bottles  
6 glass bottles  
Books - International Bottle  
Collectors' Guide  
- The Victorian Chemist  
Notes

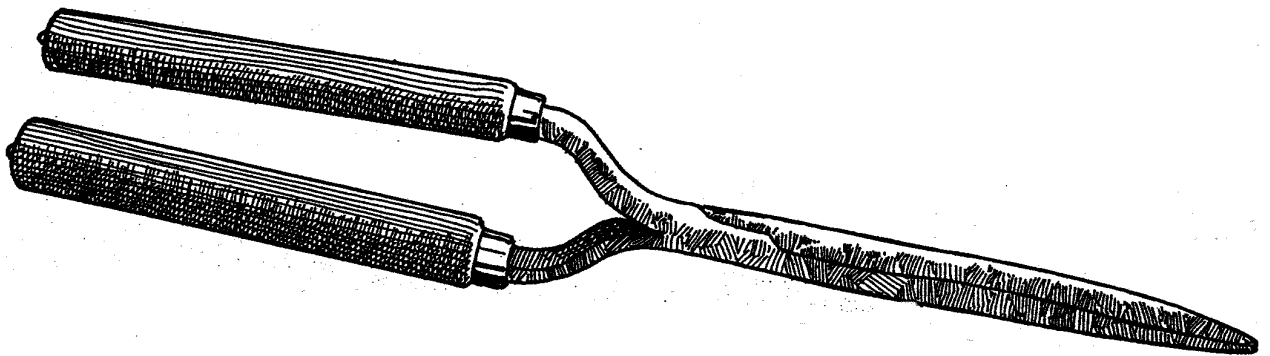

8-219A

**9-122C FASHION 1905 (MAN)**

Costume model

**9-123C FASHION 1905 (WOMAN)**

Costume model

**9-265A SEED FIDDLE**

Seed fiddle for broadcast sowing  
Notes

**9-44A 'QUICK COOKER' PUDDING  
BASIN (1910) ☺**

Basin and lid  
Notes

**9-226A BEAN SLICER ☺**

Bean slicer  
Notes

**9-183A MARMALADE CUTTER  
(1930s) ☺**

Marmalade cutter (improved  
version of 8-160A)  
Notes

**9-313A COFFEE MILL ☺**

Coffee mill  
Notes

**9-224A LIGHTING: CANDLESTICKS ☺**

Pair of glass candlesticks  
Bedroom candlestick  
Notes

**9-210A GAS LIGHTING ☺**

Wall-bracket gas light  
Wall-bracket gas light with  
Vitreosil shade  
Gas mantle  
Vitreosil shade in original packing  
Notes

**9-157A IRONS ☺**

Gas iron  
Early electric iron  
Notes

**9-34A STONE HOT WATER BOTTLE ☺**

**9-359A STONE HOT WATER BOTTLE ☺**

**9-222A INKSTAND ☺**

Plastic inkstand  
Ink wells  
Notes

**9-374A HOT WATER BOTTLE**

**9-382A DECADES – 1950S**

**9-383A DECADES – 1960S**

**9-384A DECADES – 1970S**

**9-385A DECADES – 1980S**

**9-397A DECADES – 1930s-1940s**

Decade cases contain items of  
Clothing  
Books/magazines  
China etc.

**9-399A 1930s/1940s MEDICAL  
EQUIPMENT**

Stainless steel sterilizing dish  
Enamel kidney dish  
Invalid feeding cup  
Clear glass eye wash  
Syringe in s/steel case  
Forceps  
Catgut  
Glass measuring cup  
3 s/steel dishes  
Safety pins  
Photograph of wartime nurse  
CD transcript of wartime nurse  
Books  
Notes

**9-263A TOY MANGLE ☺**

Plastic toy mangle (1950s)  
Notes

**9-287A TOY MANGLE ☺**

Plastic toy mangle (1950S)  
Notes

**9-103A STEREOSCOPIC VIEWER ☺**

Stereoscopic viewer  
'The Underworld Travel Library':  
box containing 100  
stereoscopic cards  
Notes

**9-185A TOY BRICKS**

Box of Lott's bricks  
Set of 20 picture-bricks

**9-339A GAMES OF THE 1920s & 30s**

Table skittles  
Snakes & Ladders  
Rumble Tumble

**9-340A GAMES OF THE 1920s & 30s**

Bull board  
Houp-la  
Trianhole

**9-344A GAMES OF THE EARLY 20TH C**

Lotto  
Solitaire  
Table croquet  
Patience playing-cards

**9-343A WHEELED TOYS**

1930s straw-filled duck  
1930s wooden pull-along horse  
with rider  
Train  
Model cannon  
1960s plastic sports car  
Six small wheeled vehicles

**9-380A TOY MANGLE**

Notes

**9-381A SOFT TOYS**

2 soft toys of 1940s

**9-345A LEAD TOYS**

Farm set  
Garden set

**9-350A TOY SEWING MACHINES**

Two children's sewing machines

**9-351A STRING PUPPETS ☺**

Elephant  
Tiger

**9--320A STRING PUPPETS ☺**

Boy  
Dog

**9-323A MOVING TOYS**

Walking poodle  
Rocking clown  
Pecking hens  
Pop-out bird  
Pull-along chicks

**9-357A CLOCKWORK TOYS**

Mouse  
Robin  
Dancing clown  
Train  
Mouse (reproduction)  
Bird           "  
Notes

**9-358A JOINTED TOYS**

Press-base dog  
Jointed acrobat  
Metal pecking hens  
Jointed acrobat (modern)  
Press-base donkey   "  
Notes

**9-372A COMPOSITION DOLL**

1930s doll

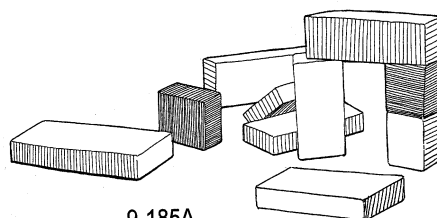

**9-250A WORLD WAR 1**

Sam Browne (army officer's belt)  
Tin of tobacco  
Two postcards  
Ration-card folder (with cards)  
Notes

**9-159A WW 2: GAS MASK**

Heavy-duty respirator in haversack

**9-209A WW 2: CIVIL DEFENCE**

Civilian-duty respirator  
Civil Defence armband  
Fire Guard's helmet  
Eyeshield, throatbrush  
Householder's First Aid case  
Various books & instructions  
Notes

**9-172A WW 2: BABY'S GAS MASK**

**9-262A WW 2: BABY'S GAS MASK**

**9-259A WW2: ARMY FOLDING SAW**

Saw & notes

**9-163A(1,2) WW 2: GAS THREAT  
(anti-contamination out-fit)**

Cloak, trousers, shirt  
Helmet, goggles  
Notes

**9-348A (1,2,3) WORLD WAR 2: FIRE**

Bucket, stirrup pump  
Helmet, arm band, eye shield  
Hand-books & leaflets  
Notes

**9-349A WW2: GAS ATTACK**

Gas rattle  
Gas mask  
Anti-dim cloth in tin  
Eye shield in sleeve  
Anti-gas ointment tubes & tin  
Remedy for poisonous gas & tin  
Book & leaflets  
Notes

**9-399A 1930/1940s MEDICAL EQUIP.**

See page 27 for items

**9-162A WW 2: AIR RAID PRECAUTIONS**

First Aid Post helmet  
Fire Guard helmet  
ARP Warden's whistle

**9-341A WW 2: HOME LIFE**

Gas mask  
Pair of ladies' & men's shoes  
Pair of glasses  
Blackout curtain  
Various books & leaflets  
Notes

**9-342A WW2: HOME LIFE**

Gas mask  
Pair of ladies & men's shoes  
Blackout torch  
Blackout curtain  
Various books & leaflets  
Notes

**9-386A WW2 FOOD RATION**

**9-387A WW2 FOOD RATION**

Replica food showing one  
weeks food ration

**9-388A REPRODUCTION GAS MASKS**

**9-389A REPRODUCTION GAS MASKS**

5 gas masks that can be tried on

**9-391A EVACUEE'S CASE**

Rag doll  
Clothing  
Book

**9-392A ANTI-GAS LEGGINGS**

Gas rattle  
ARP Handbook No.2  
Notes

**9-393A WOMEN IN WW2**

Boots, uniform, hand bag  
Notes

**9-394A ARP UNIFORM & HELMET**

Helmet  
Jacket  
Trousers  
Notes

# Miscellaneous

---

## 10-230A GENERAL COLLECTION ☺

Tea-strainer & tray  
Vacuum flask  
Hole punch  
Toothbrush  
Table knife  
Table fork  
Jelly mould  
Notes

## 10-292A GENERAL COLLECTION ☺

Hot water bottle  
Candle holder  
Patty tin  
Money box  
Flat-iron  
Pencil case  
Pair of gloves  
Baby's bonnet  
Notes

## 10-255A PAIRS OF OBJECTS ☺

Stone-Age flint knife  
Bone-handled knife  
School reading book (1930s)  
Two different clothes-pegs  
Quill pen  
Steel-nib pen  
Two different tin-openers  
Two old pennies, different dates  
Tudor horn book (replica) Notes

Vacuum flask  
Purse  
Flat-iron  
Money box  
Bone-handled knife  
Kid glove  
Notes

## 10-204A GENERAL COLLECTION ☺

### (Objects through time)

Old Stone-Age flint hand-axe  
Beads from Ur  
Four Roman tesserae  
Stone cannon ball  
Fragment of Tudor dish  
Shoe horn  
'Old' money: 1904 penny  
1967 half-penny  
Money box  
Souvenir mug of Princess  
Elizabeth & Princess Margaret  
Notes

## 10-218A GENERAL COLLECTION ☺

### (Objects through history)

Hand-axe (prehistoric)  
Oil lamp (Roman)  
Brooch (Anglo-Saxon) (repro)  
Coin (Medieval) (repro)  
Seal of Elizabeth I (Tudor) (repro)  
Royalist badge (Stuart) (repro)  
Brass snuffers (Georgian)  
Silk bookmark (Victorian)  
Reading book (20th-century)  
Nine period cards  
Notes

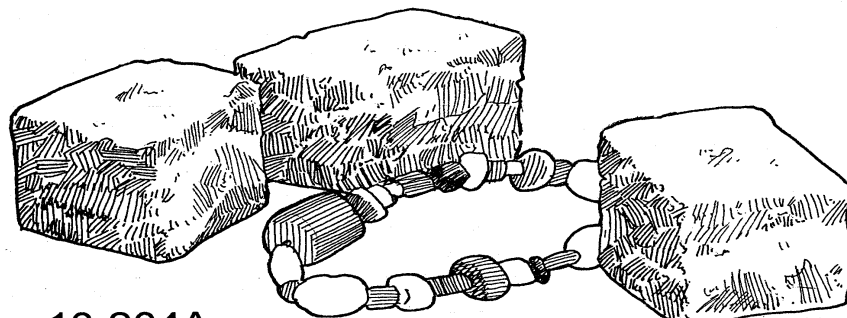

10-204A



**10-208A DATED COLLECTION**

(These objects are all dated)  
Great Seal of England 1651  
(reproduction)  
Copy of The Times 1805  
(facsimile)  
Envelope 1836  
Printer's block of an election  
leaflet 1847  
Queen Victoria's Golden Jubilee  
medal 1897  
Souvenir leaflet of George V's  
Silver Jubilee 1835  
Royal Wedding mug 1981  
Coins  
Notes

**10-246A MYSTERY OBJECTS ☺**

(mostly 19th- century)  
Scotch hands  
Window knocker  
Needle case?  
Button cleaner  
Curling tongs  
Watch stand  
Tongue- scraper?  
Hat- pin holder?  
Hat- pin  
Notes

**10-249A MYSTERY OBJECTS**

Italian iron  
Trivet  
Loaf- sugar cutter  
Mantle- hanging  
Modesty vest  
Massage roller  
Notes

**10-297A SHOE COLLECTION ☺**

11 pairs of shoes  
Worksheets  
Notes

**10-315A SHOE COLLECTION ☺**

11 pairs of shoes  
Worksheets  
Notes

**10-346A SHOE COLLECTION ☺**

(This collection is for display  
only)  
Nine pairs of shoes  
Notes

**10-347A SHOE COLLECTION ☺**

(This collection is for display  
only)  
Nine pairs of shoes  
Notes

**10-317A SHOE ACCESSORIES ☺**

Measuring gauge  
Various shoe- trees

**10-318A ELVES & THE SHOE MAKER☺**

Six copies of the book

**10-325A HATS ☺**

16 assorted hats  
Worksheets

**10-334A MONEY ☺**

Telephone money box  
Shop scoop  
Penny bank  
Victorian handbag  
5 purses  
Decimal adder  
Magic Pocket Savings Bank  
Sovereign Balance  
Currency Calculator  
£1 note  
1937 cheque  
Guide to decimal  
currency (booklet)  
'Force' catalogue  
Penn Ltd catalogue  
International Stores catalogue  
Selection of coins  
Notes

**10-360A AFRICAN STOOLS ☺**

Two carved wooden stools  
Notes

**10-115A FIRE**

Fire bucket  
Fire marks  
Notes

## Miscellaneous

---

### 10-319A TRADITIONAL TOYS & GAMES

Whip and top (reproduction) ☺  
Cup & ball game "  
Spinning top "  
Diabolo "  
Notes

### 10-214A TRADITIONAL TOYS & GAMES

Diabolo (reproduction) ☺  
Cup and ball "  
Spinning top "  
Whip and top "  
Notes

### 8-321A HOOP (child's) (reproduction)

### 8-322A HOOP (child's) (reproduction)

### 10-324A GAMES ☺

Seven wooden skittles & ball  
Dominoes  
Flip-a-ring-O & six rings  
Solitaire board & marbles

### 10-316A NURSERY RHYME CASE ☺

Toasting fork  
Sheep shears  
Enamel candleholder  
Child's washboard  
Dressing-up clothes (Bo-Peep)  
Man's nightshirt  
Sheep's wool  
Horseshoe  
Lucy Locket's pockets (repro)

### 10-332A GARDENING

Edging tool  
Watering can  
Two types of weeder  
Notes

### 10-326A FARMING

Billhook  
Turnip knife  
Sheep shears  
Bullock-holder  
Bird-scarer (reproduction)  
Notes

### 10-327A THE DAIRY ☺

Milk measure  
Stoneware butter stamp  
Scotch hands  
Skimmer (reproduction)  
Notes

### 10-260A FARMING ☺

Billhook  
Sheep shears  
Animal-feed scoop  
Notes

### 10-117A FARMING

Shepherd's crook  
Victorian sheep shears  
Cream skimmer  
Scotch hands  
Horn beaker

### 10-329A LIGHTING ☺

Small lantern (reproduction)  
Stable lantern "

### 10-336A LIGHTING

Enamel candleholder  
Slate candlesticks  
Candlestick with height-adjuster  
Brass snuffers & tray  
Rushlight (reproduction)  
Notes

### 10-370A SEASIDE: SOUVENIRS

Pressed seaweed in album  
Souvenir saucer  
Sand picture  
Oyster shell  
Collection of shells & fossils  
Photograph, book extract, notes

### 10-377A SEASIDE: CLOTHING ☺

Parasol (reproduction)  
Sailor suit & sun bonnet  
2 swimming costumes

### 10-379A PUNCH & JUDY ☺

Two puppets  
Two books: Fun & Games;  
The Smith Family at the  
Seaside

**10-398A Solent & Wight  
Maritime Archaeology  
& Maritime Aggregates**

Teaching pack info. folder

CD rom

Plastic core tube, containing  
aggregate

Real artefacts:

White plate

Shell case

Clay pipe

Pieces of pottery

Flint hand axe

Fake flint hand axe

Reconstructed artefacts:

Bone dice

Leather wrist guard

Metal arrow head

Wooden bleeding bowl

Bone needle

