



Newport and Ryde

Commercial Frontages Design Guide
February 2022



Newport & Carisbrooke
Community Council





49

COME IN, WE ARE
OPEN.



Contents

1.	Introduction	p.4
1.1.	Design Guide Aims	
1.2.	Isle of Wight's Conservation Areas	
1.3.	A Brief History of Shopfronts	
2.	The Anatomy of a Shopfront	p.9
3.	Using this Design Guide	p.16
3.1.	A Building-led Flow Chart	
3.2	A Hierarchy of Shopfront Works	
3.3	Relevant Policy and Resources	
3.4	Different Types of Consent	
4.	Design Guidance	p.22
4.1.	Street Composition and the Public Realm	
4.1.1	Assessing the Building's Façade	
4.1.2	Sustainability	
4.2.	Architectural Elements	
4.3.	Materials and Colours	
4.4.	Doorways and Accessibility	
4.5.	Signage	
4.5.1.	Lettering	
4.5.2.	Hanging signs	
4.6.	Advertisements	
4.7.	Awnings, Blinds and Canopies	
4.8.	Shopfront Lighting	
4.9	Window Displays	
4.9	Greenery	
4.10	Ventilation	
4.11	Security Measures	
4.12	Maintenance and Repair	
4.13	Living above the Shop	
4.14	Residential Conversion	
4.15	Non-standard Frontages	
5.	Example commercial frontages conversions	p.57
5.1.	Newport Example Designs	
5.2.	Ryde Example Designs	
5.3	Final Design Checklist	

1. Introduction

1.1 Design Guide Aims

This Newport and Ryde Commercial Frontages Design Guide is for shopkeepers, building owners, designers, planners, councillors, and anyone else involved in caring for shops in Ryde and Newport town centres. This user-friendly document is intended to promote positive change. It is based on Ryde and Newport's history but also looks to the future. Written to be accessible for everyone but also useful to specialists, it includes a building-led process to help non-specialists research their building and understand how to restore it. It also includes technical guidance for designers and craftspeople.

This document aims to protect the identity of our historic high streets. Please use this guide to celebrate our local heritage and encourage use of our town centres for many years to come.

1.2 Isle of Wight Conservation Areas

Newport is a medieval market town in origin. People have been congregating and shopping in the town for over eight centuries. Hardly surprisingly, it has some precious historic shopfronts, especially in St Thomas' Square and Holyrood Street.

However, much of the High Street has lost its architectural heritage. The stretch west of St James' Street is particularly affected. Sadly, it is characterised by run-down or bland, wide modern shopfronts associated with national retail chains. These shopfronts don't showcase the heritage of their buildings or of what lies within the town.

Heritage Action Zones

In 2019 both Ryde and Newport were accepted into Historic England's High Street Heritage Action Zones programme following applications from Newport and Carisbrooke Community Council and Ryde Town Council, both supported by Isle of Wight Council. A range of projects commenced in 2020 to help regenerate the two towns' historic high streets. Both towns had set out to create design guides and the two steering groups decided to collaborate, leading to the production of this guide that supports the regeneration of both town centres and other historic conservation areas across the Isle of Wight.

Ryde grew into a seaside resort in the 19th century and much of the town's impressive architecture can still be seen from the seafront today. In Ryde, approaching the town from the seafront, visitors to the town are greeted by Union Street as they climb the hill to the town centre. It's a vibrant, heritage-rich street. However, some of that sense of history and vibrancy is lost as one crosses Cross Street onto Ryde High Street.

Although half of the High Street is pedestrianised and busy with people throughout the day, Ryde High Street lacks the same "place appeal" as Union Street. A few fine, historic shopfronts, especially on the south end, are interrupted by large, national chains which don't always honour their building's history.

1.3 A Brief History of Shopfronts

The shop window was first seen in medieval shops where customers were served from a stall in the window resting on a 'stall-riser' although much trading was still done in markets and fairs. Shops became more common and some more elaborate during the eighteenth century as they started to sell what we now call 'consumer goods.' Fashion items and displaying wares became more important.

On the Isle of Wight, and especially in Newport, shops were often converted from houses, which explains the varied nature of the buildings and their varying ages. Shops which may appear to have Georgian, Victorian, or newer shopfronts often form part of far older buildings which have been refaced over the centuries as shopfront styles changed.

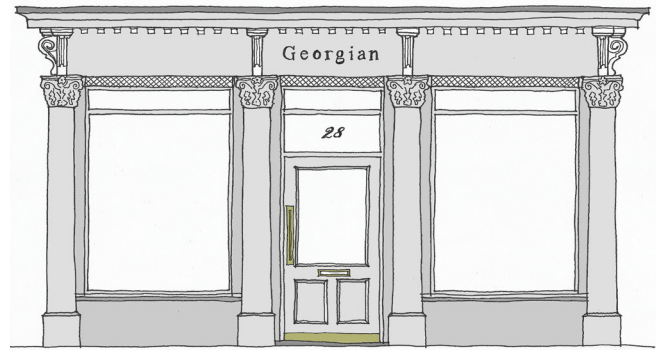
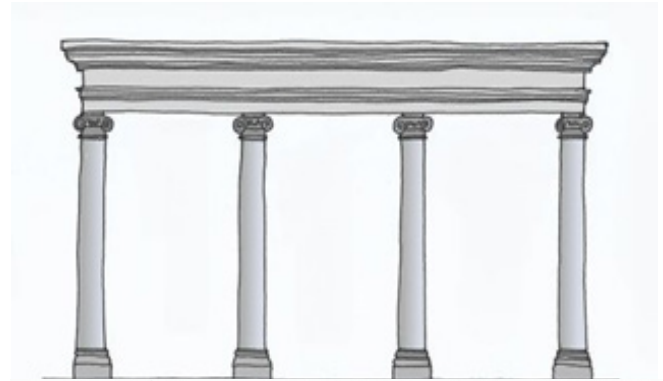

Eighteenth century shopfronts informed by classical colonnade

The classical Greek colonnade informed the design of early shops which pick up on pilasters including pediments and capitals (see section 2).

Other Georgian shopfronts can be identified by the presence of an enlarged or bow window on the ground floor.



A Georgian style shopfront in Newport



Victorian-style shopfront

The Victorians, as so often, complicated matters! They introduced new decorative details and the widespread use of shop blinds. Queen Victoria's fondness for the island attracted wealth and Ryde became a favoured destination and fashionable resort. Victorian shops which can still be found in Newport and Ryde include The Vapour Room & Gibbs & Gurnell.



An example of a Georgian ground-floor bow window, God's Providence House, Newport



A Victorian shopfront in Ryde

Many Victorian shops aimed to dazzle with their spectacle and advertising. Shops showcased new uses of materials such as glass and gold leaf; many used dramatic lighting to create an atmospheric shop window. Entirely commercial buildings, purpose built for 'shopping', were created. One well-preserved example is the Royal Victorian Arcade in Ryde.



The Royal Victorian Arcade, Union Street, Ryde

During the nineteenth century specialist production of architectural shopfront elements became more common. Distinctive 'retail' features appeared. Buildings were constructed with integrated shopfronts featuring details that continued from the shopfront to the upper storeys, such as engaged pilasters.



The engaged pilasters on this shop's upper storey would once have once framed the entire façade

The signwriter's art also flourished, extending from the shopfront to the entire façade. New commercial buildings were purpose designed and built. Many public houses were conceived as emblems of their breweries: for example, The Star in Ryde. Hotels were designed as genteel residences: for example, Calvert's on Newport's Quay Street. Banks were typically solid and reliable, normally classical, institutions: for example, Lloyd's Bank in St Thomas Square, Newport.



Art Deco shopfront, based on 8 Union Street, Ryde

In the early twentieth century, and particularly between the two World Wars, new architectural styles for shopfronts were introduced from the continent, altering the 'spectacle' of shopping, and highlighting the novelty of the goods within. Art Nouveau and Art Deco shopfronts became more popular.

Many new ventures, particularly cinemas, sought new architecture to reflect the excitement they wished to engender – some have even spoken of 'Odeon style'. The former cinema on Newport's High Street Newport, now The Slug and Lettuce bar, is one obvious Isle of Wight example. Other art deco buildings include 8 Union Street in Ryde and Elizabeth Pack.



Contemporary shopfront



Elizabeth Pack, Ryde

In the post-war period there was an increased demand for display space in shopfronts to promote the increasingly large selection of consumer goods on offer. Stallrisers and window divisions were often lost to make way for larger windows, altering the traditional shop frame. Recessed entrances also became more prevalent during this period.

Good contemporary shopfront designs often reflect older traditional designs but normally in a simplified form. Isle of Wight contemporary designs often reflect the pro formas of national corporate chains not necessarily sensitive to local character or history. The emergence of out-of-town retail parks since the 1970s has had a largely detrimental effect on high street shopfront design.

'Driving architecture' lower cost, easier-to-install shopfronts have become increasingly common retrofitted into traditional high streets and destroying their more nuanced and pedestrian rhythm. Supply chains of more traditional shopfronts atrophied though this is now starting to change. Non-retail national corporates such as bookmakers, bargain retailers, and building societies are often responsible for this could-be-anywhere aesthetic where signage and glazing area is maximised and where little or no architectural decoration or embellishment is preserved or permitted.

Increasingly however, some national bakeries, patisseries, and food outlets have been using design pro formas which, despite being national, are more sensitive to historic high streets delicacy and focus on pedestrians. When traditional shopfront components and proportions are present and quality materials are used, a pleasant, clean, contemporary aesthetic can be achieved in an appropriate way for a conservation area.

11
UNION
STREET

UNION JACK
HAIR

TELEPHONE:
01983
563771



2. The Anatomy of a Shopfront

Most shopfronts share a number of common features, whatever their date. This reflects their evolution from medieval stalls that traded onto the street, into exclusive spaces in which customers could be personally served, to the commonly accessible spaces we know today where trading is a more of a 'self-service' experience.

The design of the individual architectural elements varies from shop to shop, but what makes a shopfront a shopfront is the presence of these four integral components.

The four key elements of a shopfront are:

1. The frame
2. The shop window
3. The door
4. The signage

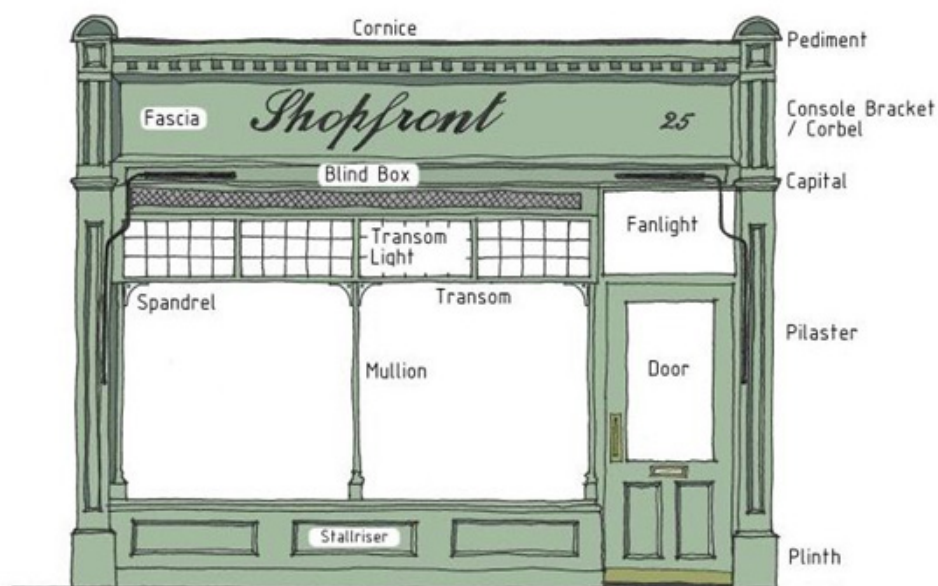

Typical traditional shopfront with architectural features labelled

1) The frame

The frame provides delineation of the shopfront as a property and distinct business. It (structurally) bears the weight of the building above, creating the broad opening in the structure for a shopfront. It should have robustness. It often stands forward from the stall and door, providing shelter and, as a frame, contribute to their beauty and invitation to customers. The architectural elements that comprise the frame are listed below.

Cornice. The cornice is the uppermost design element of the shopfront. Practically, cornices deflect rainwater away from the shop window and fascia. Visually, they provide horizontal texture to the design. Dentilled cornices can be found on both Georgian and Victorian shopfronts.



Cornice. Ryde



Dentilled cornice. Newport

Pediment. The pediment is the 'capping piece' above the console bracket. The pediment is often pitched like a small roof but can also be domed.



Pediments from Ryde and Newport. The scallop shell-type designs are commonly found in Ryde.

Pilaster. The pilasters are the column-like elements used to frame a shopfront. They are often topped by capitals and stand over the plinth. Pilasters are useful in defining the edges of adjacent properties. In some cases, the pilasters are structural and form part of a party wall with a neighbouring property. In other cases, individual pilasters are used on adjacent shopfronts, especially when located on a slope. Decorative pilasters can be made from a range of materials including stone, glazed tile, moulded render, and timber. The plinth at the bottom of the pilaster is often constructed from a more durable material, such as hard stone. This protects better against water damage resulting from water splashing up from the pavement. The plinth on the pilaster adds an additional element to the composition and is normally in proportion with the stall riser at the bottom, and the capital, bracket, console, or pediment at the top.

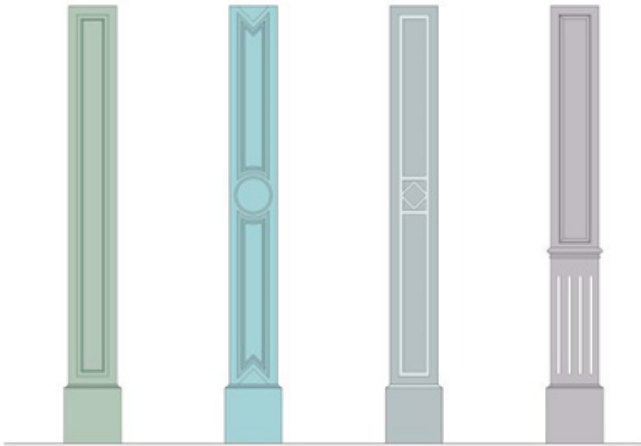

Pilasters on the Isle of Wight vary from plain to ornate and unique.

The capital is a decorative capping element at the top of the pilaster just below the console bracket or the fascia depending on the design.

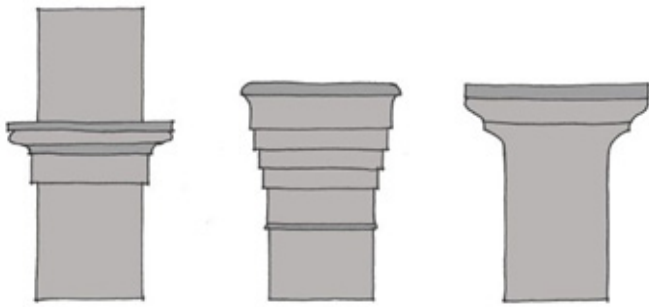

Profiles of capitals found in Newport and Ryde.

The console bracket can take several forms but is often recognisable as a decorative scroll-shaped element above the pilaster. Traditional console brackets are normally curved rather than angular.



Examples of ornate console brackets in Newport and Ryde.



2) The shop window

The shopwindow as we know it today is the descendant of the medieval shop or market stall. Historically it acts as a place of trade directly onto the street, and more commonly now is used to advertise the goods or services available within, inviting potential customers into the shop to look around. The shop window also provides light for an inviting interior space and allows passersby to see into the shop to view the available goods, otherwise known as 'window shopping'. Below is a list of the architectural components that may make up the stall or shop window.

Awning or blind. Shop blinds were common historically to keep heat off produce, to provide decoration and advertising and to 'spill' the shop into the street. They can be positioned above or below the fascia encased in a blind box. They were and are more usually found on south and west facing shops where more shading is needed in summer from mid-day and afternoon sun. They are still practical today. They can reduce the energy required for air conditioning by minimising solar gain. Awnings and blinds were most commonly used in greengrocers and butcher's shops to prolong their perishable stock's shelf life.

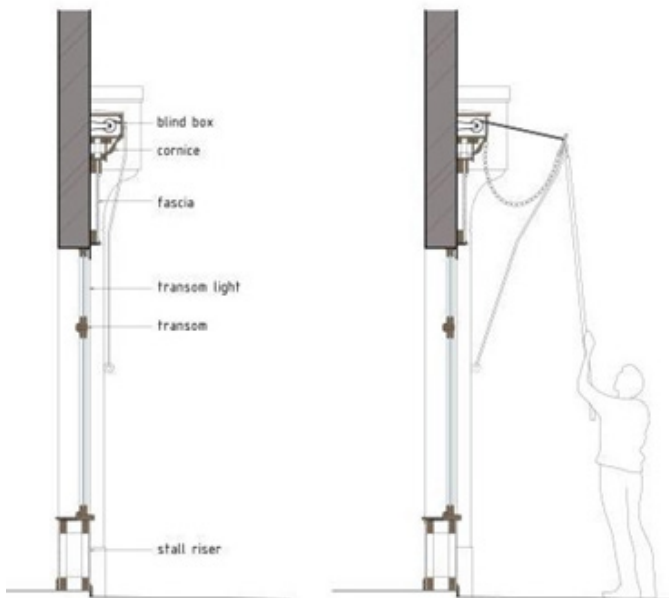

Typical section

The use of shop blinds is now rare in Newport and Ryde. Many have been removed or are in disrepair.



Historic use of blinds, Newport



Existing blinds, Ryde



A well fitted, non-integrated shop blind, London

Spandrels are normally triangular with a curved or elliptical inside edge and are usually wooden. They are often found on Victorian shopfronts. Shown overleaf is an original architect's drawing of the elevation of 30 High Street in Newport. Large spandrels can be seen incorporated into the window framing.

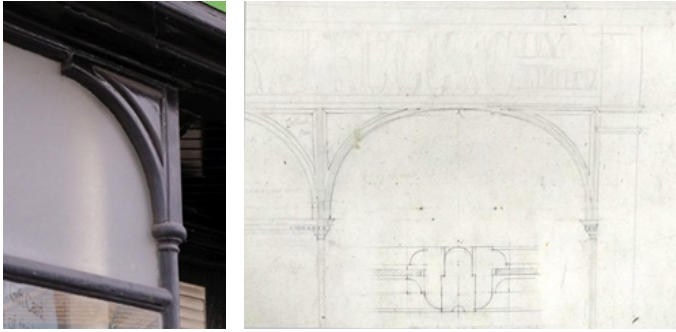

Original spandrel design for 30 High St, Newport

Transom. Transoms are the horizontal structural elements on windows. They are often located at door head height on a shopfront.

Transom lights. These are the panes at the top of the shop window. They serve practical and decorative purposes. Practically, they reduced the size of the panes of glass needed for glazing the shop window. This is less important now than it was historically. Visually, they add texture, character, and proportion to the overall elevation without affecting overall visibility into the shop.



Wooden transoms

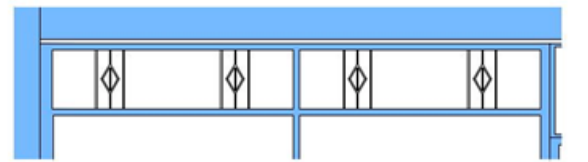
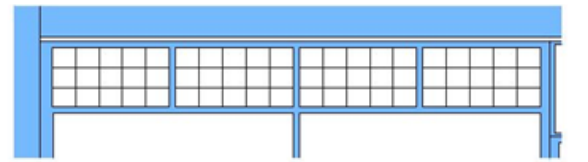
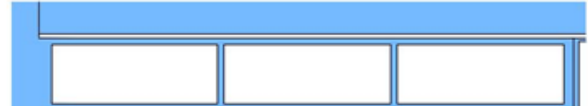
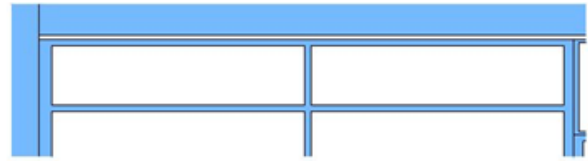

Several interesting transom light designs can be found in Newport and Ryde.



Opaque transom lights, Ryde

Stallriser. Also traditionally referred to as the stallboard, the stallriser is the base of the shopfront below and up to the lower windowsill. A stallriser needs to be in proportion to the rest of the shopfront elements (around 500mm for traditional shops). Stallrisers can be of masonry, brick (plain, glazed or rendered), tile, timber, or even vitrolite construction and can be finished in various ways. A skirting provides protection to timber stallrisers at pavement level and ensures visual tidiness. Panelling adds embellishment and texture. Ventilation grilles and traditional rising boarded shutters are sometimes incorporated into stallrisers. Timber stallrisers can deteriorate rapidly due to rain splashing up from the pavement unless properly cared for.

Mullion. Mullions are vertical structural elements in the shop windows. They can be plain in design or ornate as in some Victorian examples.

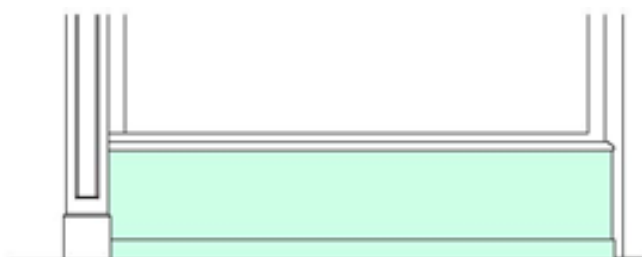

Plain stallriser



Panelled stallriser



Exposed brickwork

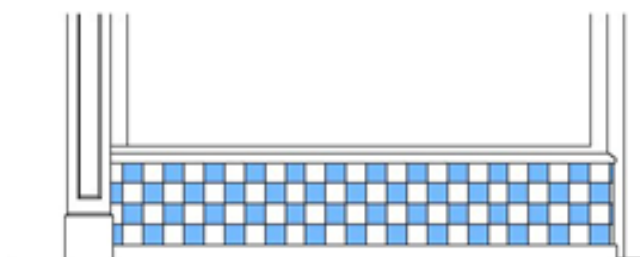

Ceramic tiles



Mullions in Newport

3) The door

The shop door is very important in drawing customers into the shop and needs to be both practical and clearly readable as the entrance to the shop. Shopfront doors will usually be glazed to increase visibility into the shop. Doors can include panelling and decorative door furniture in the form of door handles, escutcheons, kick plates, push plates and letter slots.

Rails and stiles. Regardless of the material used to make the door, the construction will consist of a bottom rail, top rail, stiles on the sides and an optional horizontal lock rail positioned at about a third of the height of the door. Lock rails will only be needed if the door is to have panelling incorporated on the lower half.

Fanlight. A fanlight is the window that is sometimes present above a shopfront door if the height of the shopfront permits. Fanlights present a design opportunity where elements such as glazing bars can be incorporated.



Spandrels used in the top corners of a door's glazing, Newport

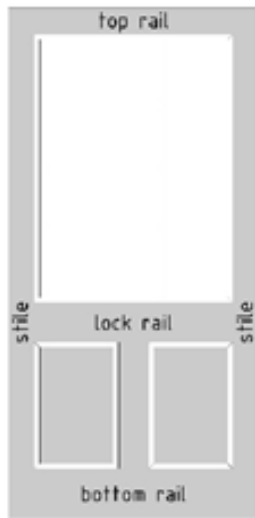

Labelled diagram of a door

4) The signage

The signage identifies the business to customers. It can provide brand recognition and some indication of the service/goods on offer. The fascia is the key part of any shop sign.

Fascia. The fascia is the horizontal board above the shop window where the shop sign is displayed. The fascia frames the shopfront and communicates the business's commercial purpose and 'personality' to potential customers. Traditionally fascia boards were made of wood. Some tilt towards the carriageway. Others are flat on the shopfront.



Examples of high quality fascia from Newport and Ryde

3. Using this Design Guide

3.1 A Building-led Flow Chart

If you are a shopkeeper or landlord of a commercial building within a conservation area, this flowchart takes you through a step-by-step process to help you approach a redesign or refurbishment of your commercial building:

As you make your way through the step-by-step process, the flow chart will suggest a recommended approach based on your building's current condition.



Useful links:

Details of all conservation areas across the Isle of Wight are available here:

www.iow.gov.uk/Council/committees/Planning/Conservation-and-Design/Conservation-Areas

Isle of Wight Council Record Office and Archives details are available here:

www.iow.gov.uk/Residents/libraries-cultural-and-heritage/Records-Office/

Isle of Wight Historic Environment Record containing records of historic buildings as well as photographic collections details are available here:

www.iwight.com/Residents/Libraries-Cultural-and-Heritage/Heritage-Service/Archaeology/About-us

Further details of planning consents are available here: www.planningportal.co.uk/

Further advice on historical conservation are available here: historicengland.org.uk/advice/technical-advice/

Top tips:

Community groups often share historic photos of their local area via social media platforms.

Historic local societies often have members with specific local knowledge that can help when redesigning shopfronts. *Historic Ryde Society* is one such group.

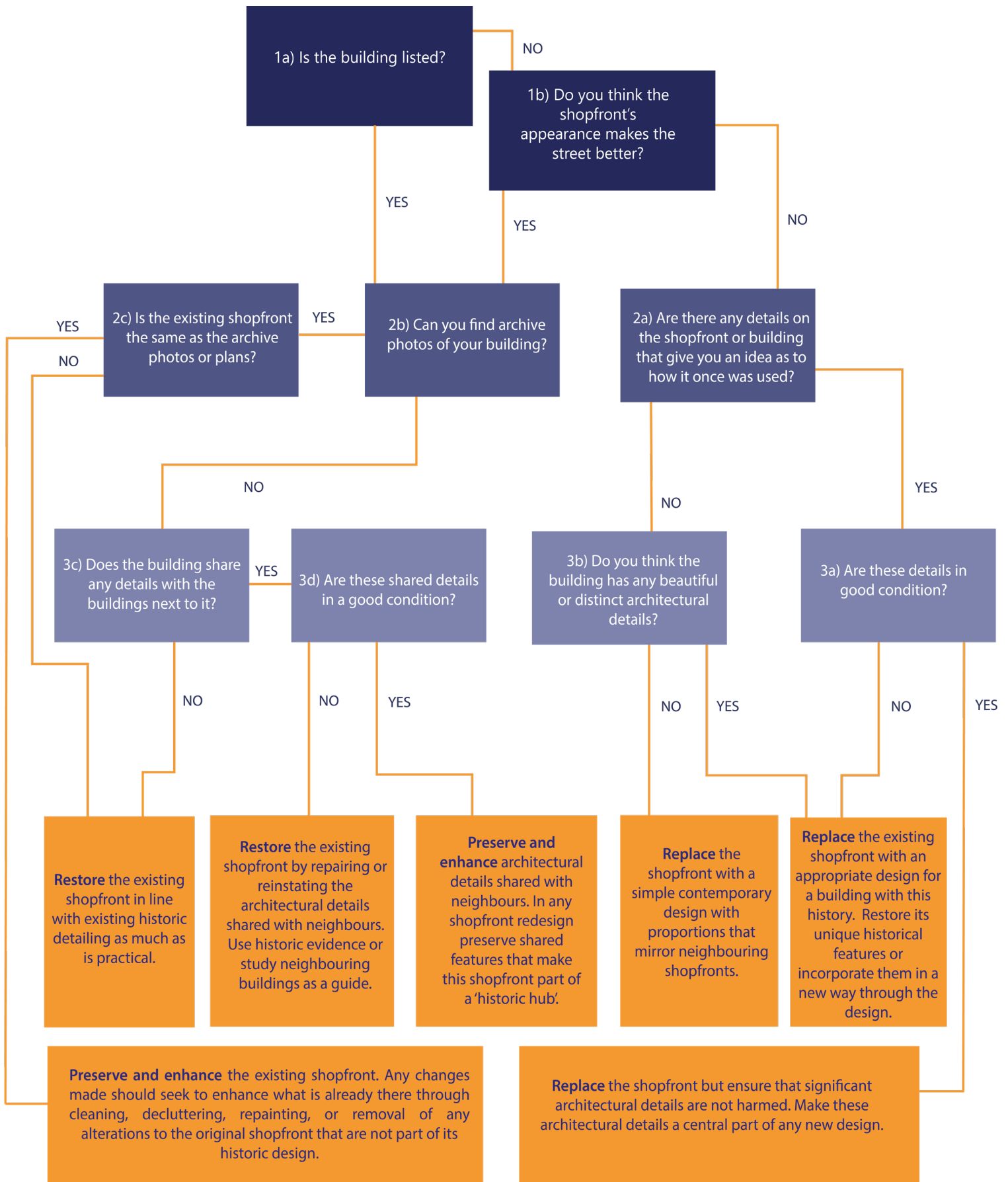

3.2 Hierarchy of Shopfront Works

These are three tiers of interventions that should be considered when improving a shopfront:



1) Cosmetic Refresh



2) Repair & Reinstatement



3) Renewal

Nearly all shopfronts can be improved. Within a conservation area even minor improvements have a major effect on local character. This guide recommends that all shopfronts should consider the first level of improvements. If, subsequently, more is required then the option to move onto stages 2 or 3 should be considered.

1) Cosmetic refresh

A cosmetic refresh is an affordable and effective way of improving a shopfront's appearance without needing planning permission or building regulations approval. Normally, this should be the first option you consider.

How?

- Keep signage to a minimum
- Keep window displays simple but interesting
- Avoid window vinyl advertising that blocks out whole windows and doors
- Avoid unattractive wiring and ensure necessary features such as burglar alarms are sensitively located
- Repaint stallrisers, pilasters and window frames.

2) Repair and Reinstatement

Sometimes a building that has lost its architectural details or is in a poor state of repair can be given a new lease of life through a programme of repair and reinstatement.

By showcasing how long-lived and well-integrated within the local area a building is, new tenants or potential purchasers can be assured that their building has character, will work for their brand and business, and will encourage customers who are attracted to the historic frontage.

Collectively, well conserved and maintained historic shopfronts add to an area's 'place appeal' and its ability to attract pedestrians and shoppers. Restoring architectural features can also indicate that an area is 'on the rise'. Supporting and enhancing a neighbourhood's established character can demonstrate that a business is making a serious local commitment and is likely to 'stick around'. By contrast, less well integrated commercial frontages can often indicate impermanence and detract from the local sense of place.

Repair and reinstatement involves limited changes to the existing shopfront, depending on the scale of modifications to the original design. It may require planning permission or building regulations approval depending on the degree of change. Reusing existing features is a cost effective and environmentally friendly method of upgrading a shopfront. It is also an effective way to ensure modifications are well integrated into the existing frontage. It is important to always repair or replace on a like-for-like basis with any original shopfront details being reinstated. This is particularly important where shopfronts contribute to the character of conservation areas or are listed. The exception to this being that some changes for greater sustainability may be desirable. Technical drawings from library archives and photographic records online can help identify original shops design and details if lost. If original records cannot be found, use designs that are in-keeping with the character and detail of similar buildings and shopfronts.

How?

- Repair and reuse existing features
- Smaller repairs, sanding, repainting, or paying a joiner to reinstate a lost detail should be less expensive than installing a whole modern shopfront. It is also more likely to meet planning requirements
- Check online and in local library archives for authentic original shopfront designs that could be reproduced or photographic evidence of lost features
- Select appropriate materials in coordinated colours
- Remove or relocate roller shutters or grills inside
- If there is a step or slope, consider ways to improve accessibility
- Upgrade doors to be assisted opening for mobility aid users.

3) Renewal

Shopfront renewal usually involves significant, sometimes structural, changes. It will almost certainly require planning permission and building regulations approval.

How?

- Start by considering the shop's proportions. Think about the symmetry of the overall design
- Design windows to balance the shopfront. Windows on a single shopfront should all be the same in design
- If there is not separate access to the upper storeys of the building, consider if it is possible to create new access at street level without compromising the appearance of the shopfront. This will increase the useability and value of the building as a whole. Reinstating residential use above and reducing the shopfloor size can significantly reduce the rates payable for a shop premises.

- Select appropriate materials and colours. This is particularly important in conservation areas. Where appropriate bright colours can be used, but saturated colours may be overly garish. A consistent colour palette should normally be used with a limited number of coordinated colours
- Ensure fascias are proportionate to the rest of the shopfront, where possible using the proportions of historic shopfronts as a guide
- Ensure projecting and hanging signs are appropriately located and sized not protruding more than 750mm from wall to sign edge. There should be no less than 3m in height from the ground to the top edge of the sign. The dimensions of the sign should not exceed 750mm by 750mm
- Avoid using bulky internally illuminated box signs. Externally illuminated signs and hanging boards may be more acceptable, although wiring and lamps will need to be carefully located. Halo illuminated individual letters may also be more acceptable. The latter could, for example, reflect the signage used for some inns and 'warehouses' (actually just larger shops) in Ryde and Newport in the late nineteenth century
- Design the doorway and inside of the shop to ensure access for all, including wheelchair users and prams and to be easily identified as the entrance for users with visual impairments. Using a slight recess to the doorway can help to make its location more evident and help to accommodate a ramp in the entrance if needed
- Ensure canopies and awnings suit the character and period of the building. However, any brackets need to be sufficiently visible and at a height that they will not impede pedestrians
- Keep shop windows visible at night, preferably by using security glass windows and window displays illuminated by low level LED lighting.

3.3 Relevant Policy and Resources

A summary of relevant national and local policies is listed below. This list is not exhaustive but presents a synthesis of background policies that form the legal basis for planning regulations within high streets and conservation areas. If you need to know more about the planning guidance affecting your building, these are a good place to start.

National Planning Policy

The National Planning Policy Framework (NPPF) outlines the role of the planning and development process nationally in creating high quality places in which to live and work in a way that is supported by the local community.

The NPPF supports development within town centres that reflects the distinctive character of the local area.

The NPPF states that design quality should be a fundamental consideration in the development and assessment of planning proposals. Development should, add to an area's overall quality; be beautiful in terms of architecture, layout, and landscaping; be sympathetic to the local character and heritage; create places that are safe, inclusive, and accessible and promote public health and well-being.

The full NPPF (July 2021) is available online at assets.publishing.service.gov.uk

Local Planning Policy

The following policies from the March 2012 Isle of Wight Core Strategy form the policy context for shopfront renovations, renewals and works to high street buildings. They are significant in the determination of planning applications.

For the full list of policies, the Core Strategy document available online at [iow.gov.uk](https://www.iow.gov.uk)

- *DM2 Design Quality for New Development* outlines expectations of development proposals in terms of design, function, access, safety, and adaptability. This policy states that development proposals which preserve or enhance a Heritage Asset, or the setting of a Heritage Asset will be supported.
- *DM9 Town Centres* outlines how proposals are expected to contribute to the diversity, choice, vitality, and viability of town centres. This policy references higher density, mixed-use development, and the importance of being sympathetic to the local design vernacular.
- *DM11 Historic and Built Environment* outlines the council's support for proposals that positively conserve and enhance the special character of the Island's historic and built environment. This policy references the demolition or substantial harm of both designated and non-designated heritage assets and their settings.

In July 2021 a draft Island Planning Strategy was published for public consultation. The final Island Planning Strategy will specify revised policies for the Isle of Wight's development between now and 2038. Upon its publication, the policies referenced above from the Core Strategy of March 2012 may become outdated.

Different types of consent

Most shopfront alterations require planning permission. This section outlines which approvals apply to different types of works. All applications are considered against relevant planning policy and legislation. Specialist advice should always be sought regarding the need for consent.

Planning Permission is required for most alterations to a building's exterior, including alterations to the shopfront. Completely replacing a shopfront will require planning permission. Conversion to residential will require planning permission or prior approval from the local planning authority.

Listed Building Consent is required if a shop is part of a listed building under the Planning (Listed Buildings and Conservation Areas) Act 1990 for any minor or major alterations to any aspect of the shopfront, building exterior or building interior. Specialist advice should be sought for proposals affecting listed buildings at the earliest possible stage. Unauthorised works to a listed building can lead to prosecution.

Consent to Display an Advertisement may be required depending upon the type and location of the advertisement and whether it would be illuminated. Canopies or awnings with signage (lettering for advertising purposes) are considered advertisements and may require advertisement consent, rather than planning permission. It is advisable to seek specialist advice at an early stage to establish if consent is required.

Prior Approval Application may be necessary "to be eligible for permitted development rights allowing a conversion of a shop to a residential use. This enables the local planning authority to consider the proposal and, if within a conservation area, where the impact of residential conversion may be more pronounced, to assess the effect on the character of the conservation area and the amenity of the future residents. Specialist advice should be sought at an early stage.

Building Regulations Approval is required for new shopfronts when alterations affect the building's structural stability, means of escape, or the position of the entrance or doorway. Replacing windows, doors or roof coverings on pitched and flat roofs requires Building Regulation Approval. Specialist advice should be sought at an early stage.



4. Design Guidance

4.1 Street Composition and the Public Realm

While the design of individual shopfronts is crucial, it is also important to take into consideration the design of a shopfront in relation to others along a commercial street. The following diagrams highlight good and bad practices.



An example of a group of shopfronts with poorly designed proportions



An example of harmonious shopfront proportions across a row of shops



Shown above are some general, recommended proportions for shopfront design based on local precedent

Proportionality: Proportionality is the balance between different elements of the whole picture. In this case, the whole picture is the building frontage. Proportional design aims to achieve visual consistency. In simple terms, when things look balanced, humans like it. Knowing what is and is not proportional can mean relying on your senses. Sometimes building frontages just 'feel off' because their proportions are not well-balanced.

Tools such as the Golden Ratio can be helpful for understanding proportionality. This is a ratio within the elements of a form, such as height to width, at approximately 0.618. In terms of commercial frontages, ensuring that no part of a shopfront feels much too large or much too small is a good start. Looking at examples of quality shopfronts that date from the same time period as your own will help.

Frontage: A frontage of a building is a wall facing a public place. In this context, the building frontages are facing onto the High Street or public squares. The frontage covers both the shopfront and the upper storeys of the building. It refers to everything you can see as you look at a shop from the street as a pedestrian. Another term for frontage is façade, which refers to the front exterior of a building.

HAIR leaders
LIMITED
TELEPHONE
01983 521215

HAIR leaders Ltd
Ladies & Gents Stylists

leaders
LIMITED
TELEPHONE
01983 521215
Ladies & Gents
Stylists

42

WILKING GREEN
LANE

4.1.1 Assessing the Building's Façade

The shopfront is just one part of the building's façade. Shopfront improvements should be considered within the context of the whole building. A newly refurbished shopfront can fail to make the improvement desired if the upper storeys remain in disrepair. Normally, conserving an upper storey's original features will be paramount. Where these features are in poor condition, they should be repaired or restored referencing the original design wherever possible. If features have already been lost, then they can either be replaced on a like for like basis, or with more modern features that are sympathetic to the building's character. Generally, where Listed Building Consent or Planning Permission are required it is best to restore the architectural and historic interest of the building if possible. Some common issues and solutions relating to the upper storeys of high street buildings are listed below:

Windows and the quality of the frames and glazing can make a huge difference to the overall appearance of the building frontage. Decaying historic windows should be repaired where possible or replaced like for like if beyond repair. Opportunities should be taken to replace non-historic poorly proportioned windows with new windows matching the proportions of the original windows as closely as possible. If there is no evidence available showing the building's original windows, seek further guidance or refer to other buildings of a similar age or appearance to use as a guide.

Maintenance. The walling material (brick or render) and rainwater goods (gutters and downpipes) should be cleaned and maintained regularly to minimise decay and water ingress.

External Fixings other than those of the historic shopfront (such as brackets for canopies) should be avoided as much as possible to preserve the walls' texture and the building's appearance. Security devices should be concealed or located sensitively. Other non-essential fixings should be avoided on the building frontage. All redundant fixings should be removed, and masonry repaired to improve the appearance of the building and avoid unnecessary decay and damage.



Shopfront improvements should be considered within the context of the whole building.

Paintwork needs to be properly maintained in an appropriate colour. Shopfronts are traditionally dark colours, often just black, as is other external joinery, such as bargeboards. In fact, historically dark colours were used for all external joinery such as window frames. This began to change from the 1860s, when white became more common, although many darker windows could still be seen in the 1940s. Dark green was favoured as it resembled verdigris bronze, reflecting the bronze window frames of the richest. There can therefore be a case for painting the window frames of any building built before 1860s a dark green, or another dark colour. Historic building frontages in both Newport and Ryde have often been painted a bright white on the upper storeys in recent years. Creams and neutral tones should be chosen. Light pastel colours may be appropriate on some frontages but dark paintwork on the upper storeys should be avoided where there is no evidence to suggest that this was part of the historic design.

4.1.2 Sustainability

Upgrading our building stock to reduce energy use will make an important contribution to the country's targets to achieve a zero-carbon economy. In July 2019 the Isle of Wight Council declared a climate emergency. A draft Climate and Environment Strategy was published in December 2020 online at iow.moderngov.co.uk.

Heritage-led design honours the history of a place and climate-conscious design safeguards a place for the future. Shopfront design can help support climate action in a number of simple but effective ways:

Longevity. Buildings and shopfronts that last the longest are the most sustainable as the carbon embodied in their design is not lost but remains in use. The greenest building is the one that already exists. It is nearly always more energy efficient to repurpose a building than to start again. Ways to maximise longevity include:

- Investing in long-lasting materials safeguards the building for the future. Properly maintained traditional materials can last many years without the need for replacement.
- By designing buildings with flexibility in mind, the building is more likely to be used in the future. Buildings that can work as either residential or retail units and offer street level access to the upper storeys allow the use of the space to evolve over time. Overly precise purpose-built shopfronts become defunct once the business moves or closes down.
- Reusing existing features not only preserves the historic character of the building frontage, but also bypasses the need to produce new features.

Street use. By making shops and the street a more comfortable place to be, people are encouraged to spend time in their local high street and shop locally rather than, perhaps, drive to a less sustainable out of town option. Simple but effective ways of making the street more comfortable and enticing include:

- Blinds and awnings can be used to reduce solar glare, making the interior of the shop more comfortable and protecting the goods being sold, preventing waste.
- Blinds and awnings can be used to provide shade on the street, allowing people to dine and shop outside.

Energy Efficiency. Historic buildings perform differently to modern buildings in terms of energy efficiency. Measures shopfronts can adopt to improve energy efficiency include:

- Blinds and canopies protect windows from the sun therefore preventing the shop from overheating
- Insulation. Insulating shopfronts is difficult owing to the large windows. Where possible, insulating the upper storeys is an effective energy efficiency measure
- Ventilation through opening transom lights is a cost-effective and natural way to improve air flow through a shop, helping to control temperatures. This reduces the need for electronic air conditioning
- Double glazing helps to regulate the temperature of the shop's interior. Particularly using slimline, evacuated glass double-glazing reduces the thickness of frames needed to accommodate it.

See further guidance from Historic England on energy efficiency and historic buildings online at historicengland.org.uk.

Slice of Life Café



4.2 Architectural Elements

The Signage

Fascia

- The height of the fascia should not normally be more than 15 to 20 per cent of the entire shopfront height



A poor example of an excessive fascia in Newport where the fascia makes up about 50 per cent of the entire shopfront. This makes the shop look like a billboard rather than a commercial premises.

- The fascia should not be built over existing architectural details such as cornices, blinds or ventilation panels, or the sills of first floor windows. The fascia should be kept within the extent of the original design and not extend further out, below, or above.



A poor example of a modern fascia mounted on, and obscuring architectural detail of heritage value.

- In cases of shopfront replacements or refurbishments, the height or depth of any new fascia should not exceed the height or depth of the original fascia. If there is evidence of the position of the original fascia on the shopfront these boundaries must be respected. Extending the fascia downwards (covering over the original window area, including transoms) is also considered undesirable.
- The fascia may be angled slightly downwards on traditionally designed shopfronts. The angle of the fascia is achieved by adding an additional timber mounting batten at the top. The fascia on modern shopfronts need not be angled, but if the fascia being replaced was tilted then the replacement should also be tilted, both to reflect the original design and to make it more visible to pedestrians.



An example of an additional horizontal, timber batten supported by vertical post and used to achieve an angled fascia.

- In some cases, oversized, deep facias conceal steel beams below timber bresssummers or low-level false ceilings that provide fire and sound separation between the ground floor and upper storeys. In these cases, correctly proportioned and positioned facias may look unsightly. A solution to this problem is to introduce a sloped shopfront. This allows for a historically accurate fascia to be fitted without exposing any structural elements of the shopfront. It also permits extra natural light within the shop.

- In cases where a low false ceiling is unavoidable, historic fascia proportions can be kept by adding false transom lights which can be glazed and blacked out.

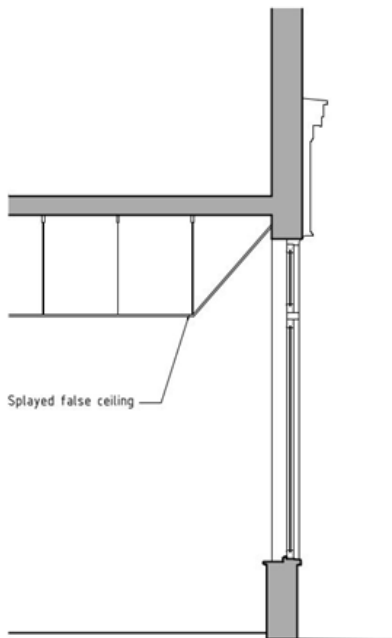
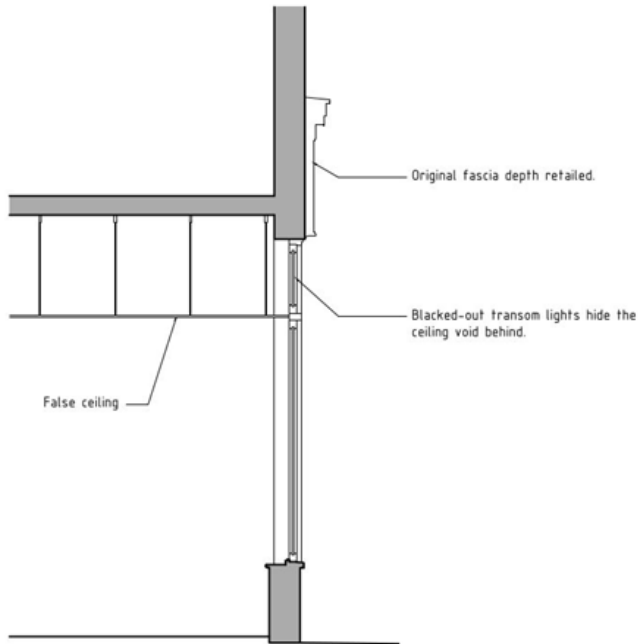

Coloured glass can be used in transom lights to conceal a low-false ceiling inside the shop



Increasing the opacity of transom lights allows false ceilings to be concealed without compromising the appearance of the shopfront

In situations where false ceilings are unavoidable, fascias should not be made deeper to cover over transom lights. Splayed ceilings should be used where possible or blacked-out transom lights should be used to hide the ceiling void behind. With both solutions, the original fascia depth can be retained.

The Frame

Console bracket / corbel

- Most traditional console brackets in Newport and Ryde are curved. This is the preferred style for any new design. A straight, angular console bracket should only be used for reasons of historic precedence rather than for ease of construction.
- Traditional cornice profiles should be used when undertaking a restoration or constructing a new shopfront in a traditional style.
- Modern shopfronts should also have a projecting cornice with enough embellishment to achieve shadow lines, add interest to the streetscape and ensure that dripping rainwater is kept away from the fascia and shop window.

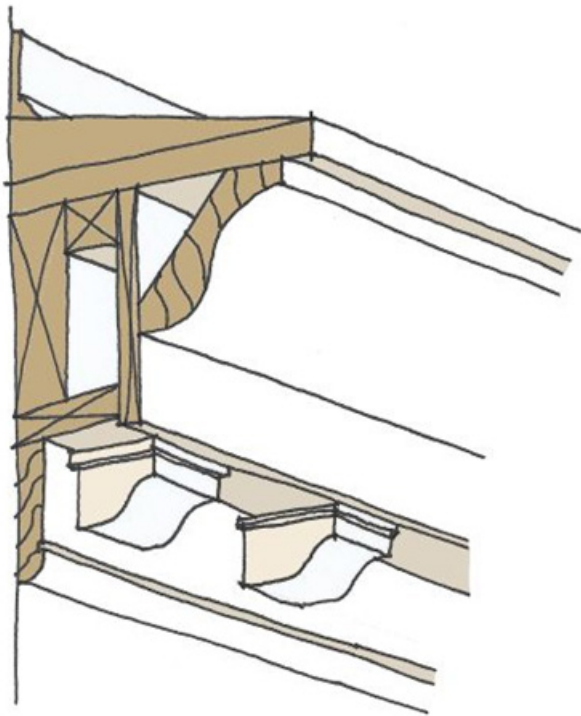

Traditional dentilled cornice construction with cyma recta moulding



Ideal cornice overhang (L) contained within the extent of the console bracket.

Pilasters

- Missing timber pilasters should be reinstated and should form part of the restored or new shopfront. Proper maintenance and regular repainting are essential to prevent water damage.
- Sometimes where shopfronts have been modified from the original design, load bearing masonry piers or steel columns are present. If the steel columns do not disrupt the shopfront they can be left on display. Timber boxing can be used to mask thick masonry piers by using a traditional pilaster design. In the case of very broad columns, these could be split to appear as two pilasters side by side.



Double Pilasters, London.

The Shop Window

Spandrels

- Use of spandrels on new shopfront designs should be considered when some embellishment is needed to make a plain design more interesting. Including spandrels is a simple way of adding a sense of heritage to a shopfront. They do not require complicated design. They can be manufactured and fitted independently of the window frame. Care should be taken to ensure that spandrels form an integral part of the shopfront design and are fitted with longevity in mind.
- Transoms are usually located at door head level but are sometimes higher in historic examples. The historic use of transoms was to break up tall shop windows to strengthen large areas of glazing and, by placing them above head level, avoid interfering with views of displayed goods in the shop window. However, they can also add to the beauty of the design, for example through use of decorative moulded sections or more intricate design such as bowed lines, adding interest and framing to the shopwindow display.

Transom Lights

- Transom lights should be considered to help create well-proportioned glazing, or in cases where they were part of the historic shopfront design.
- Transom lights that can open are a practical way of catering for natural ventilation. Opening sections are usually bottom hung, opening inwards.

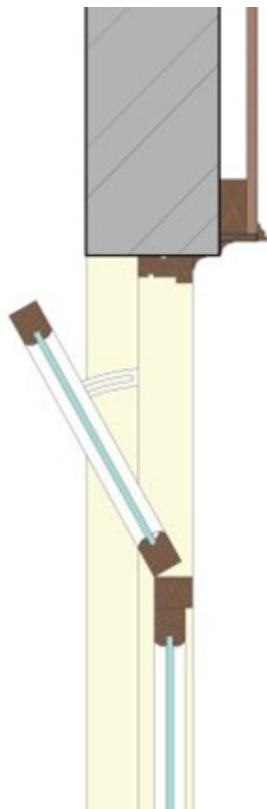

Bottom hung, opening in transom light.



Examples of interesting transom lights' designs found in Ryde

Stallriser

- Stallrisers should normally have a minimum height of 500mm from the internal finished floor level.
- A skirting to a stallriser should normally be considered as it provides practical protection to a timber stallriser as well as providing 'visual tidiness.' In maintenance terms this may be a sacrificial element that is replaced every few years rather than replacing the stall riser as a whole.

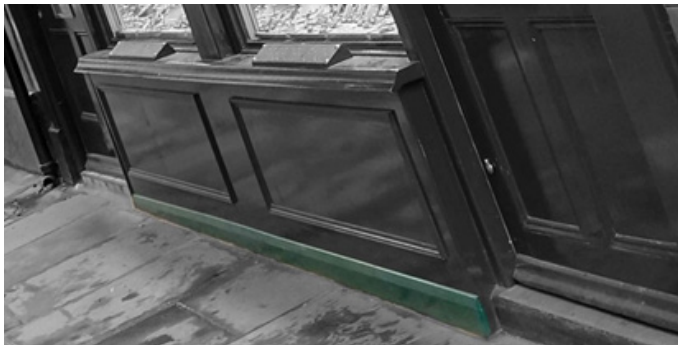

A timber skirting or kickboard on a panelled stallriser, London.

- Panelled stallrisers add interest and texture and should be considered when appropriate for the building's age and in keeping with neighbouring shops.
- Glazed ceramic decorative tiles can be considered as a finish for stallrisers. There is historic precedent for their use in the Isle of Wight and they are also practical as a durable alternative to timber stallrisers.



Ceramic tiles on stallrisers, Newport and Ryde.

Mullions

- Where appropriate, mullions on new designs should include some form of embellishment (not necessary decoration) such as fluting, beading or splayed edges rather than being entirely plain. Historically, panes of glass above a certain size were expensive and potentially brittle. Mullions provide a larger window using several panes and strengthen the frame. Even today, (where plate glass is more readily available) insurance costs are reduced according to the reduced size of windowpanes, as larger panes are still more susceptible to breakage.
- Mullions and any glazing bars should be of the slenderest construction possible to maintain the fine texture associated with historic timber framing on shopfronts. Broad, over-sized members generally associated with PVC frames should be avoided.

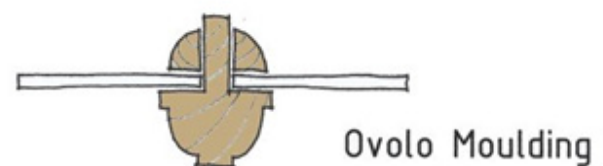
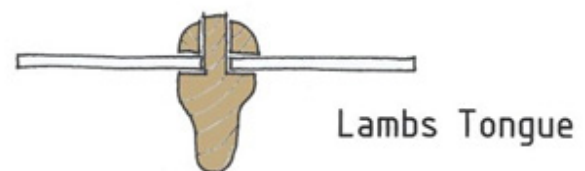
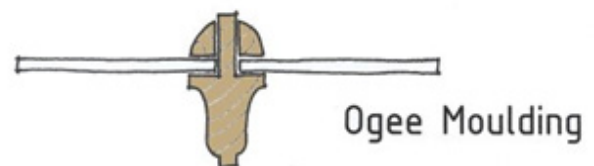

Traditional timber mouldings.

4.3 Materials and Colours

- Common wall materials on Newport and Ryde shopfronts include red brick, yellow brick and stucco or render.
- Common ornamentation materials on Newport and Ryde shopfronts include joinery, stone and ceramic tiles.
- Leaded transom lights are commonly found in both towns, especially on art deco buildings.
- To ensure good quality, long-lasting construction of new shopfronts, solid timber panels should be used where possible and budget plywood avoided. Where the use of plywood is unavoidable, high quality marine ply is preferred and should be strictly treated according to manufacturer recommendations.
- Shopfronts should not contain too many different materials but should use two or three (for example: stone, glass and metal trim, or glass, timber and tile).
- Non-traditional sand, lime or cement renders should not be used in historic buildings (i.e. those built before the common introduction of these materials in the period after World War I). The predominant element of a shopfront is the glazing. However, excessive use of glazing should be avoided. Modern shopfront design trends have tended to neglect stallrisers and transom lights in favour of floor to ceiling glazing. To maintain traditional proportions of new shopfronts and to add a finer texture to the appearance of new shopfronts, both stallrisers and transom lights are recommended and preferred.
- Another consideration for designers is the potential difficulty of supply of large and curved panes of glass to the Isle of Wight, another reason to opt for smaller rather than larger panes. Shopfront colours should be compatible with the existing building and surroundings. Traditional shopfront colours used on the Isle of Wight are pastels and dark muted colours. These are 'recessive' and don't over-dominate the view allowing the

shopfront to be seen with the building and wider streetscene, but also providing a strong frame to the shop window (and display) without detracting from it. These should normally be used.

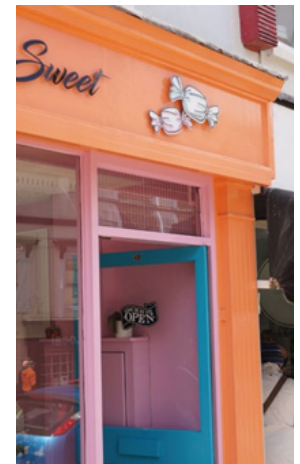

Examples of suitable colour choices from Newport and Ryde



Recommended colour palette showing muted colours.

4.4 Doorways and Accessibility

Shopfront design should be as inclusive as possible.

- For all elements of design relating to shopfront accessibility, Part M1 of the national building regulations for England should be complied with. Seek specialist advice on buildings other than dwellings.
- New shopfronts should have level access with the pavement. If this is not possible, ramp access should be provided. This can be achieved through the use of temporary or removable ramps and may be accommodated within a recessed or 'lobby' entrance. In cases where this cannot be accommodated, further specialist advice should be sought.
- To obviate the need for a step or a ramp when a shopfront is on a slope, every attempt should be made by the designer to locate the door at a point where the pavement level is the same as the internal floor level of the shop. (See diagram below).



- Doorways to new shopfronts should have a minimum effective clear width of 1000mm.
- New door handles should be easy to operate from a wheelchair and allow for a clear opening. When possible automatic doors can be installed.

- Careful use of colour contrast can help to identify the location of an entrance to a visually impaired user, whilst ramps instead of steps also help to reduce the potential for trip hazards at shop thresholds. If a step is unavoidable, consider adding a handrail in the doorway on the opening side.
- All shops should avoid permanent barriers around the shopfront.

300mm minimum unless door is power operated

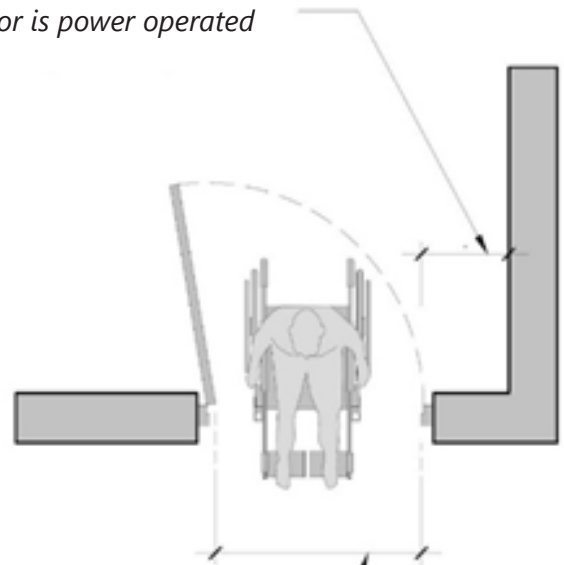

Effective clear width (door stop to door leaf)

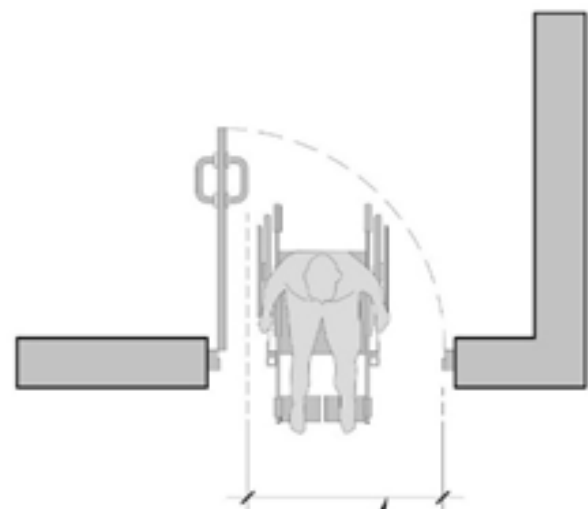

Effective clear width (door stop to projecting ironmongery)

4.5 Signage

4.5.1 Lettering

- The lettering on shopfront signs should be easily legible but within proportion of the fascia. Traditional shopfront lettering on the Isle of Wight tended to be tall with small margins around the edges, but narrow, leaving plentiful contrasting 'background' colour when used on shallow fascia boards.
- The letters' colouring should stand out against the colour of the fascia board.
- Lettering should be applied directly to the fascia rather than applied to a board then fixed to the fascia.
- Traditional lettering on shop signage was hand painted on timber fascias and this is encouraged wherever possible and appropriate. Modern signage manufacturing allows for signage options in metal, vinyl, acrylic, timber and even foam. Signage materials should be robust and suitable for outdoor use as well as sensitive to the architectural heritage. Vinyl and foam lettering applications should be avoided for the sake of longevity as should acrylic signage to avoid a plastic appearance to new shopfronts.
- The use of shadows on the lettering was considered a cost-effective alternative to raised lettering in the nineteenth century. More recently, it helps convey a shop's age where appropriate.



Historic archive photographs show the use of the largest possible letters when sign writing. Newport. Note the signwriting on the stall riser also.



4.5.2 Hanging Signs

Hanging signs are not mandatory for shops. They can be used on narrow shopping streets where the view to the shop sign is limited, for example Watchbell Lane in Newport. Hanging signs are an opportunity to use unique, playful, and attractive designs both in the hanging bracket and the sign itself. Hanging signs not only advertise a shop but can also encourage pedestrians to look up and enjoy the street.



Examples of unique hanging signs which help add character, interest and a sense of playfulness.

- Hanging brackets' design should be sympathetic to the building onto which it will be fixed. They can and should be 'fun.'
- Hanging signs should not protrude more than 750mm from wall to sign edge. There should be no less than 3m in height from the ground to the top edge of the sign. The dimensions of the sign should respect the size of the shopfront they represent and not exceed 750mm by 750mm. This is to ensure that the sign does not obscure the view of the street. Consideration must be given to the occupants of the first floor if hanging signs are proposed above shopfront level.



Essentially
Wight

visual
impact
LADIESWEAR

Fancy
Dress
Shop

Hanging signs in Watchbell Lane, Newport

4.6 Advertisements

Advertisements on shops' elevations should generally be in keeping with their overall character.

- Advertisements should normally depict a trade or service that is relevant to the business displaying the advertisement
- Advertisements should not cover the detailing of a building. They should not cover architectural ornamentation or shopfront windows.
- Advertisements should not protrude at any angle from the building face unless on a hanging sign
- Third party advertisements and product advertising should not be present on fascia. The fascia should be reserved for the name of the shop only. Any third party or product advertising should be limited within the shopfront window in a way that does not cover the entire window.



Clear and simple signage works best



Overly cluttered shopfronts are discouraged



An example of a shopfront with clear and effective signage and advertising that keeps the shop windows free from clutter

4.7 Awnings, blinds, and canopies

- North facing elevations do not normally require blinds.
- For elevations that require shading, the blind box design should be incorporated into the cornice if located above the fascia. If the blind is to be located below the fascia, then the fascia should be of a design that incorporates the blind box. This is to avoid the blind box sitting proud of the fascia for the sake of a neat design. If the blind cannot be incorporated into the fascia, then provision should be made for adequate flashing to avoid water pooling as well as drip detailing to avoid rainwater streaking on the shopfront. The box design should also prevent pigeon roosting and nesting without the need for unsightly bird spikes.
- If a protruding blind box is unavoidable (for example if retrofitting an existing shopfront and the addition is justifiable) then the box design should incorporate features to mitigate rainwater ingress such as sufficient overhang of the capping, lead flashing and a drip recess in the capping of the boxing.
- Fixed, Dutch canopies must not be used as they are not retractable. Awnings should be retractable. The exception to this is the folding Victorian Dutch blinds characterised by timber side brackets.
- Where replacement blinds are needed on Georgian or Victorian shopfronts, traditional blinds should be reinstated. If non-traditional, mechanical blinds are unavoidable, then these should be housed within traditional wooden boxing and not modern, metal frames.
- Awnings should be made of traditional fabric such as canvas. Plastics and other shiny fabrics should not be used as they create undesirable reflection. Plastics are more difficult to repair and therefore less sustainable.



Folding Dutch Blind, London



A good example of a blind that is not integrated into shopfront, London

- Canopy colours should complement the overall colour palette of the shopfront and surrounding context. Alternatively, the colours could reflect the traditional colours used by specific trades (for example, blue and white for butchers, green and white for grocers, red and white for barbers).



Non-retractable Dutch blinds should not be used



An example of complementary colours on a shop blind. London. The valance at the bottom of the awning adds an additional fascia to the shopfront.



Historical precedents of canopies in Ryde



Canopies, rather than Dutch blinds, are preferred

4.8 Shopfront lighting

- Shopfronts can help streets feel lively and safe at night by illuminating their signage and window displays
- Shops' signage should normally be lit using an external source directed onto it. This can include spot, bar, halo, and hidden LED lighting.
- The intensity of the lighting source should be moderate to avoid glare and light pollution. The light itself should not spill beyond the fascia and should be of a warm colour temperature to be inviting and provide an appropriate urban or town centre character.
- Where appropriate, the use of period correct lamps mounted on the cornice helps add to the architectural character of a high street
- Internal illumination of translucent signs should not be used
- The sign should only be lit where lettering is present. Plain fascia boards should not be lit.



A good example of lighting with three traditionally-styled lamps, London

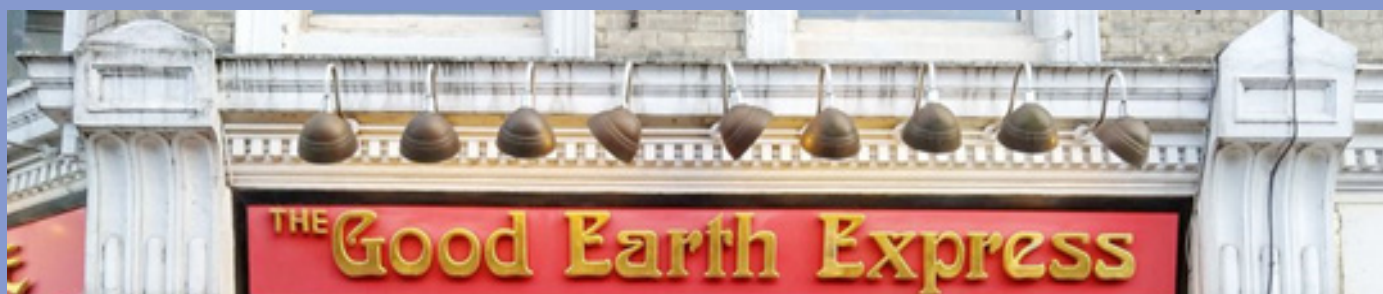

A poor example of shopfront lighting with too many lamps, London

ADRIENNE WROATH



4.9 Window displays

Shop windows do not just display goods and explain services, they also contribute to the vibrancy, atmosphere, and character of the street both in and out of operating hours. Whilst window displays are not subject to planning guidance, they can impact the success of a business and street. Going back to their medieval origins they 'set out the stall' but coming into the modern era their job has been to draw the customer into the shop rather than necessarily being the place where buying and selling happens.

- Good internal lighting is important to bring attention to a shop window display. The choice of colour can help reinforce a brand and will tie the display to the rest of the shop.
- Introducing smaller light sources such as table lights can also add interest to the shop's contents and the building's character
- Window displays should change to match the seasons, national holidays or special events. This will prevent the shop from appearing stale and will add intrigue for both residents and visitors.
- Overly cluttered displays should normally be avoided. Showcasing some merchandise is normally preferable.



A shopfront in Ryde clearly presents the products sold with an attractive, simple window display.



A bright and inviting window display in Newport.



An uncluttered, well-lit window display in Ryde adds interest and intrigue.

GREETING CARDS

SPLASH

JEWELLERY

lifeline
alarms
(01893)
521621



4.10 Greenery

- Shopfronts can be adorned with greenery, such as potted plants, vines and box plants. Greenery helps to create more vibrant streets and should be used 'little and often.' However, the need to water greenery and the potential harmful impact that overflow, splash, and rips, including the chemicals in any plant feed can have on the shopfront and building facing materials should be carefully considered.
- When designing in greenery, for the sake of preservation, efforts should be made to avoid any fixtures attached to historic, decorative features.



Hanging baskets provide just the right amount of greenery



An example of excessive greenery that obscures the view of the fascia



An example of excessive greenery using false plants, London

4.11 Ventilation

- Like the Victorians were concerned about air quality, energy use and communicable diseases, today ventilation should still be considered as an essential part of new shopfronts. Proper ventilation also reduces reliance on air conditioning, improving a shop's energy efficiency.
- The most practical way of ensuring good natural ventilation and cooling is to include opening transom lights. Examples of opening transom lights can be found on Georgian and Victorian shopfronts with some Victorian shops incorporating ventilation grilles between the transom lights and fascia.
- Other shopwindows include vertical sliding sash sections which, if used properly by opening both sections halfway, providing a very efficient means of ventilating and cooling the room (hot air flows out at the top and cold air in at the bottom). These features often reflect historic use of buildings for sales of perishable goods, including bakers, fishmongers and butchers and are likely to be considered important to the building and area's historic character.



A 'hopper opening' transom light, Newport

- Ventilation can also be achieved by incorporating grilles into the panels on the front of stallrisers. Stallriser grilles should be designed in sympathy with the rest of the shopfront elevation and should be sympathetic to symmetry scale, colour, and materials. Grilles and vents should not appear as arbitrarily, retrofitted items. They can, however, be extensive and may be needed to ventilate basements.

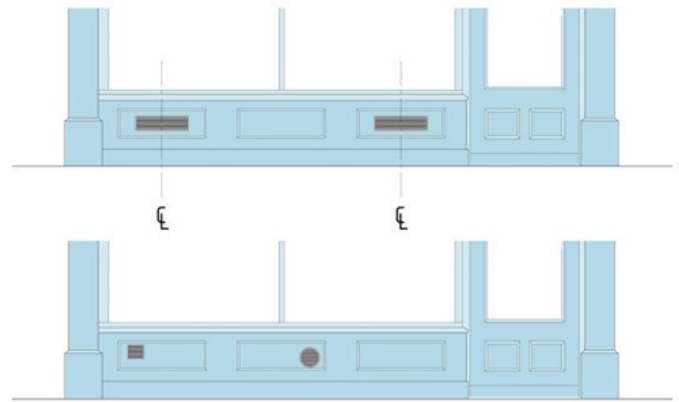

A good example of stallriser vent (top). A poor example of vent placement (bottom).

- On existing Victorian shopfronts, every effort should be made to restore or reinstate blocked-up ventilation grilles and opening transom lights which are shut fast, as these make an important part of the building's functioning apparatus.

4.12 Security Measures

Shutters. Security should be provided by laminated glass or internal lattice grilles. Where possible, laminated glass is preferable. External roller shutters should not be used as they contribute to a sense of vacancy on the high street and have a negative effect on the night-time economy by reducing active frontage.

Electronic devices. Devices such as sirens and lights linked to burglar alarms should be concealed or located sensitively to reduce the appearance of clutter and to avoid damaging the historic fabric. This also applies to electrical wires, satellite dishes and other antennae, including those used for flats and other rooms above the ground floor. To preserve the texture of the brick or render it is advisable to avoid fixings on heritage assets which can lead to structural damage. Electronic devices should only be used where the need for them has been demonstrated and alternative ways to reduce threat and risk have been considered. Depending on the type and location of the device, planning permission is likely to be required.



A poor example of electrical wiring and electronic devices cluttering a shopfront, London.



Security shutters should not be used externally, but instead behind internal lattice grilles, or preferably, laminated glass

4.13 Maintenance and Repair

Maintaining a timber shopfront to a good standard requires yearly checks and touching up of the paintwork, especially around the windowsill and joints in the framing (commonly required as a 7-year maintenance item). For larger repairs, timber can be scarfed-in around the joints by a qualified joiner, whilst minor areas of repair could be undertaken using resins. Keeping on top of repairs helps to ensure that the shopfront continues to invite people in and avoids large bills further down the line.

Rendered or timber-panelled stallrisers can be subject to a lot of damage, especially if they are carried down to the ground without any gap or damp-proof course. Splashback from the road and pavement surface are a constant problem leaving them dirty and stained and more susceptible to decay. Regular cleaning can mitigate this and highlight minor repairs at an early stage. Unless inappropriate given the historical architectural context, using stone or glazed brick, with a damp-proof course, is a very good long-term solution for stallrisers.



A poorly maintained traditional shopfront in Newport



Timber stallriser suffering from bad damp



The effects of poor maintenance can clearly be seen on this shopfront joinery



4.14 Living above the Shop

Traditionally, shopkeepers lived in flats above their ground floor shops with access to the upper floors from inside the shop. Many of the shops that did originally have separate street level access to the above storeys have since lost this due to subsequent modifications.

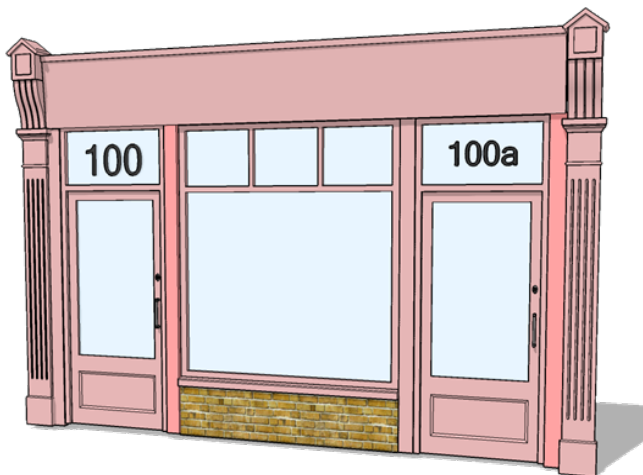

Living above the shop is possible – even on a narrow front

Separate entrances are needed off the street to allow more flexibility in the building's use. Entrances to flats above the shop wherever possible should be from the front not from the back. An example is seen for the proposed re-design of 100 High Street in Newport (page 61) above.

Adding a residential entrance to a narrower frontage might use a recessed lobby to provide angled access to the shop. This requires a clear differentiation between the commercial and residential entrances. Signage needs to be clearly visible and relevant to the location of the commercial door. If possible, separating the commercial and residential entrances, so as to not be side by side, reduces potential confusion. Ensure the commercial entrance has greater prominence. Seek to create symmetry with doors and window but ensure the signage placement is relevant to the commercial entrance.



An example of residential access to the property above incorporated into a shopfront, Newport

4.15 Residential Conversion

Many high street shops across the country have been, are being, or will be converted into homes. There are reasons cautiously to welcome this.

- *There are too few homes in some places.* There is an undersupply of homes in much of the country, including many traditional town centres, leading to major affordability pressures. The ratio of homes to households is tighter in the UK than almost anywhere (0.99 versus a European average of 1.12)¹.
- *And too many shops in some places.* In parallel, there is an oversupply of shops in many high streets. Savills analysis estimates that the UK currently has 158 million square feet of vacant retail space, equivalent to 12 per cent of retail units – rising to nearly 17 per cent in some regions. Shops have, over the last century, taken over many town centre buildings that were previously used as homes or for other purposes.
- *Greener homes.* The built environment sector creates up to 40 per cent of UK greenhouse gas emissions. To reduce this, we will need to get better at repurposing old buildings for new uses, not just building new ones. For example, constructing a new-build two-bedroom house uses up the equivalent of 80 tonnes of CO₂. Refurbishment uses only eight tonnes.
- *Often cheaper.* Converting existing buildings is also often cheaper than building new homes – meaning that financial support for new homes can go further. Converting an existing building is on average £670 cheaper (35 per cent) per square metre than building afresh.

However, conversion needs to be done correctly. Poor examples of retail to residential conversions are very common, especially, regrettably, in less prosperous neighbourhoods. Formerly transparent shopfronts are often replaced with brick walls and unsustainable PVC windows, creating dissonant gaps in high streets. The gentle rhythm characteristic of historical high streets becomes destabilised, often resulting in a downward spiral, and the 'variety in pattern'

which most of us find so attractive is lost. This is not just a matter of 'aesthetics'. Poor design can discourage further investment in a place². Retail to residential conversions will come with implications for rubbish and bin storage which are not always easy to resolve.



Examples of poor residential conversions

Where historic shopfronts survive, successful retail to residential conversions are those which do the least, almost imperceptible from their neighbouring shopfronts. They may have frosted glass or curtains in the windows rather than shop displays, but the historic shopfront will be preserved almost entirely intact, and the rhythm of the high street retained. Where a contemporary conversion has been substituted, it will follow many of the same principles of successful shopfront design, such as a simple colour palette and an uncluttered appearance.

- If the historic shopfront was better quality than the existing shopfront, then converting the existing poor-quality shopfront back to a more historically accurate shopfront style residential should be considered. This approach is particularly appropriate if the immediately surrounding street is mainly shops.
- If the building used to be residential, then converting the ground floor façade back to a residential façade should be considered. Wherever possible, evidence of the original residential façade should be used as a guide. This approach is particularly appropriate in instances where the immediately surrounding frontages are mainly residential.

In all matters of conversion, it is crucial to maintain as much flexibility for the future as possible. The high street should continue to feel like a high street.



Examples of good quality residential conversions

Where the retention of the existing shopfront is neither possible nor desirable, there are normally two advisable options. Any historic evidence available showing what the façade used to look like should be used to inform decision making.

E FAYRE Est. 25 years

Fruit & Vegetables Telephone 525836
"Growing on the Island for the Island"



NOW IN
I.O.W
* ASPARAGUS
* AUBERGINES
* TOMATOES
* EGGS



4.16 Non-standard Frontages

Non-standard frontages are commercial or community buildings which were not designed with a traditional shopfront that still form part of the commercial frontage. Examples include pubs, hotels, banks, and churches. These commercial frontages do not necessarily display the four integral components of a shopfront (frame, stall/shop window, doors, and signage), but are still recognisable as places of commerce and public life through careful design.

It is increasingly common for such buildings to be used for new purposes. What once was a bank may now be home or a restaurant. These non-standard frontages can be very popular with the public. For example, Newport's Man in the Moon pub was the most popular commercial frontage in Newport in a 2021 community survey.



A non-standard commercial frontage in a 17th century building, The Castle Inn, Newport

The most successful non-standard frontages are those that make the least invasive changes to the building's exterior. The heritage of the building should be preserved despite change in use. That said, as non-standard frontages were designed for different purposes, care is often needed to ensure that the business in the building is clearly legible to people on the street.



The Man in the Moon is one of the most popular examples of a (now) commercial frontages in Newport according to the survey undertaken in support of this guidance. It reuses the frontage of the former Congregational Church with minimal additions.

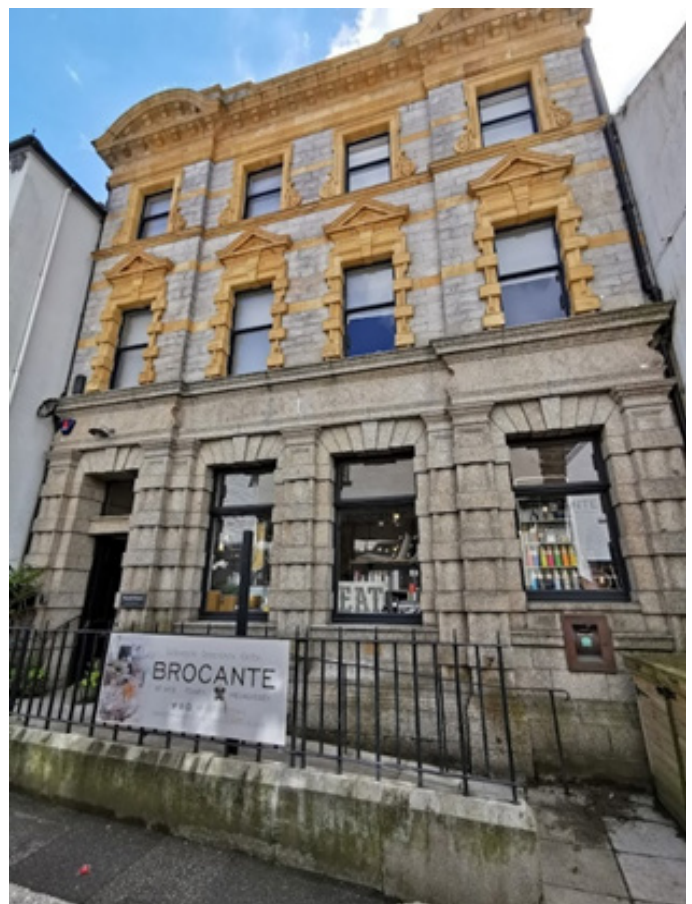

An example of a good conversion of a former bank for use as a shop with minimal design intervention in Cornwall.

As a general principle for converting non-standard commercial frontages for a different commercial use, less is more.

- Unless there is evidence of a traditional fascia board on the commercial frontage, a fascia should not be installed. Installing a traditional fascia without the other standard shopfront components will look out of place on a non-standard commercial frontage.
- Options for signage on a non-standard commercial frontage include individual 3D lettering, projecting signs and hanging signs. If further information is needed on the commercial frontage, such as opening times, a 'menu-style' board made from traditional materials such as wood can be used by the building entrance. Signs hand-painted directly onto render have proved historically popular and could be incorporated into non-standard frontages and represent an opportunity to add artistry to the frontage. Nevertheless such proposals should be discussed with the council.
- Without traditional shopfront components where to place lighting can be less obvious. For individual 3D lettering signage, halo-lit signage can be an effective method. Traditional lamps can also be used but should be orientated to light up the signage only. If the building is of some architectural significance or acts as a public landmark, such as a former chapel, ground-based up-lighting can be an effective way of illuminating the whole building at night.
- The original windows and window frames of the building should be preserved, or, if necessary, restored to their original design. Frosting out windows should be avoided as this creates a blank frontage and less inviting atmosphere on the street. Roller blinds can be used to display the name of the company in a way that does not block out the whole window.
- The colour and materiality of the existing building should not be changed. Original raw materials, such as stone, should not be touched. If there is existing joinery or brickwork, these can be painted in

appropriate, not overly saturated, colours if preferred.



Costa coffee in St James' Square, Newport is an example of a poorly retrofitted shopfront onto a non-standard commercial frontage that used to be a local inn.

- Getting the entrance right to a non-standard building acting as a shop is often tricky. It should be clear to people on the street that it is a shop entrance. Large, cumbersome doors such as those on churches or historic banks should be conserved as they are significant components of the building's heritage. However, they may not feel very inviting. It may be possible to fix these doors open during the day (but close them at night) with secondary lighter glass doors inside a lobby to permit people to see into the shop and create a more commercial welcoming entrance.
- Active frontages can be achieved by using the immediate outdoor space. A-signs are commonly seen outside cafes and restaurants. These can be effectively used with non-standard frontages where signage space can be more challenging so long as they don't impede the use of the pavement. Greenery can also be used following the 'little and often' guidance to create an active frontage that contributes to the street. Where such buildings have their own forecourt these may be particularly suited to use for outside seating.

26 GRAINS

MENU

PORRIDGE - 5 GRAINS, APRICOT OR PEACH
COMPOTE, CARDAMOM GRANOLA,
CRÈME PÂCHÉE, MATCHA 6.50

BIRCHER COLD BOWL - OATS + CHIA, APRICOT CURD,
TOASTED SEEDS, YOGHURT, CHERRIES

BRIOCHE - SCRAMBLED EGGS, GLOUCESTERSHIRE CHEESE
CRISPY ONIONS, HERBS 7.50

SALAD - PEA, FETA, FRISEE, SPELT, PRESERVED
LEMON DRESSING, HAZELNUTS, SEEDED
CRACKERS

FOCACCIA - HAM HOCK, MUSTARD, CRISPY ONIONS,
PICKLED CUCUMBER, 8.00

AUBERGINE, TOMATO RELISH, BUTTER BEAN
PATE, PICKLED BEETROOT 7.50

AVO TOAST - JOWDROUGH, AVO, GARLIC OIL,
DUKHAN 6.00

COFFEE 3.00

PASTRY 3.50

5. Example Commercial Frontages Conversions

This chapter presents some example redesigns in Newport and Ryde. These should be thought of as 'serving suggestions', examples of how the design process in this document can be interpreted and followed in different situations. These should hopefully provide some inspiration for what can be done.

In each case, a suggested design process is set out step by step, with recommendations for both the shopfront and upper storeys.

There are four shopfront clusters in Newport and five in Ryde. The guide sets out a total of 30 commercial frontage redesigns within the Ryde and Newport conservation areas. The examples include a range of shop types: small and large; new and old; simple and ornate. In some cases, evidence of the historic building design has been found online or in library archives. In other cases, no evidence has been found. In all cases, the standard design process has been followed through with very different outcomes depending on the context.

Research stage:

Step 1 *Understanding your building*

Key Questions:

Is the building listed?
Do you think the shopfront's appearance makes the street better?

Step 2 *Discovering your building's heritage*

Can you find archive photos of your building?
Are there any details on the shopfront or building that give you an idea as to how it was once used?

Step 3 *Assessing your building in detail*

Does the building share any details with the buildings next to it?
Do you think the building has any beautiful or distinct architectural details?

The recommended approach...

Based on the answers to the questions above, one of three approaches will be recommended: cosmetic refresh; repair and reinstatement; or complete renewal.

5.1 Newport Example Designs

Hub 1, Newport

Hub 1 in Newport is located on the western end of the High Street. It has the highest number of shopfronts in any of the hubs. It was selected because of the range of shopfronts. Some approximate their existing appearance, some are entirely retrofitted and others are more of a mix of different periods. The location of this hub is of strategic importance as it is the part of the High Street that joins St James' Street.

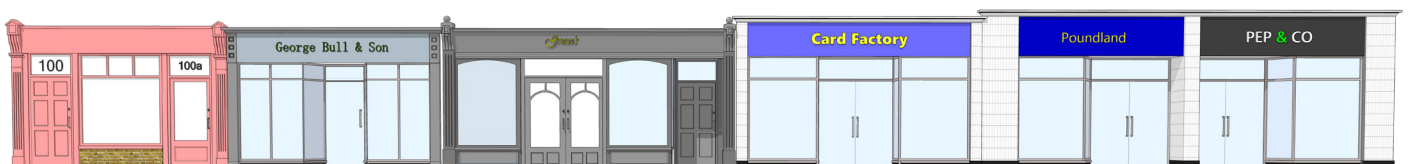
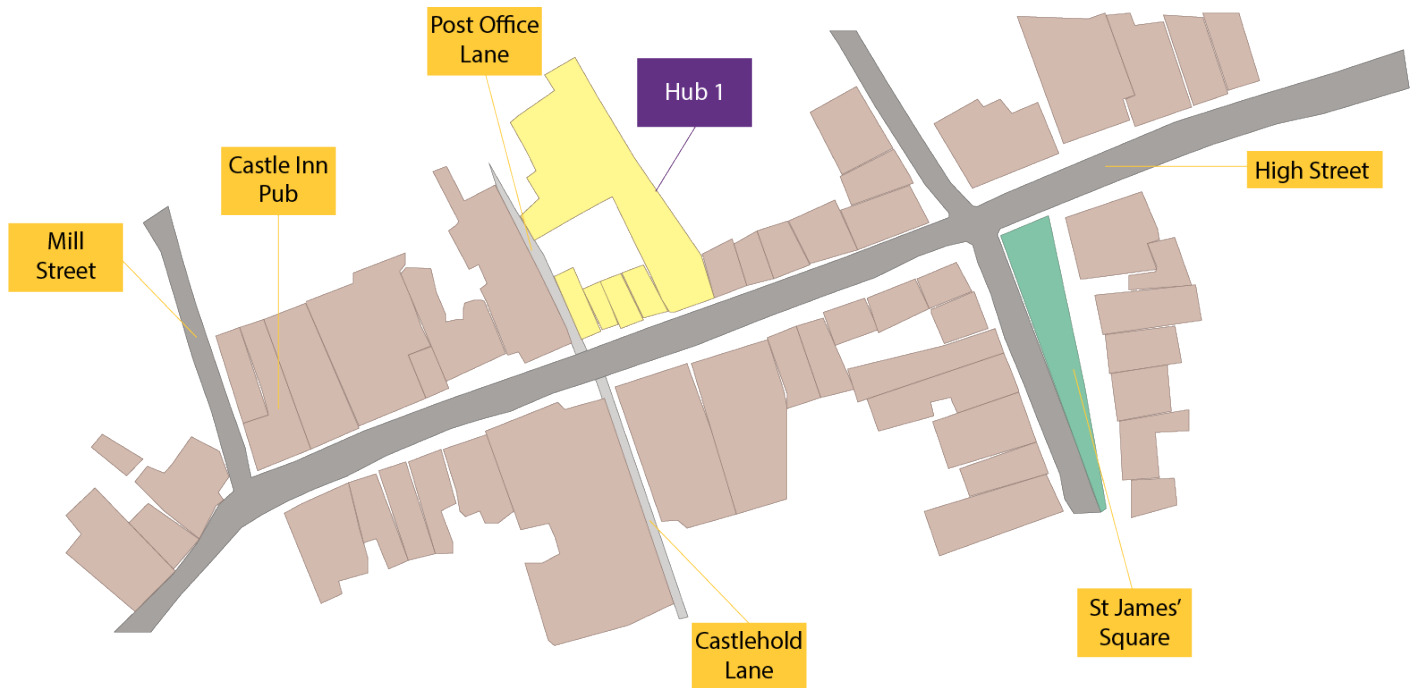

Example redesign of hub 1, Newport



Hub 1, Newport, shopfronts

Hub 1, Newport 100 High Street

Step 1 *Understanding your building*

This building is not listed, and the existing shopfront could be greatly improved to both improve the quality of the building frontage, and the sense of place on the street. The upper storeys have some positive elements, such as the ornamental bargeboards that hint at a Victorian origin but have lost their unique detailing over time.

Step 2 *Discovering your building's heritage*

In library archives, historic designs relating to the first storey have been found. These show an ornate oriel window in technical drawings from 1879. From these drawings, we can confidently say that this is a Victorian building and can consider the building's heritage as part of the shopfront redesign.

Step 3 *Assessing your building in detail*

The existing shopfront has no significant architectural that should be preserved as part of a shopfront redesign. On the first storey, however, there is a surviving street lantern that now holds a CCTV camera. The round window (an oculus) on the second storey and bargeboards to the eaves above are significant architectural features that should be preserved.

The recommended approach...

Shopfront renewal. The existing contemporary shopfront looks at odds with the building above. A new shopfront would greatly improve the appearance of the building within the conservation area.



Existing shopfront 100 High Street

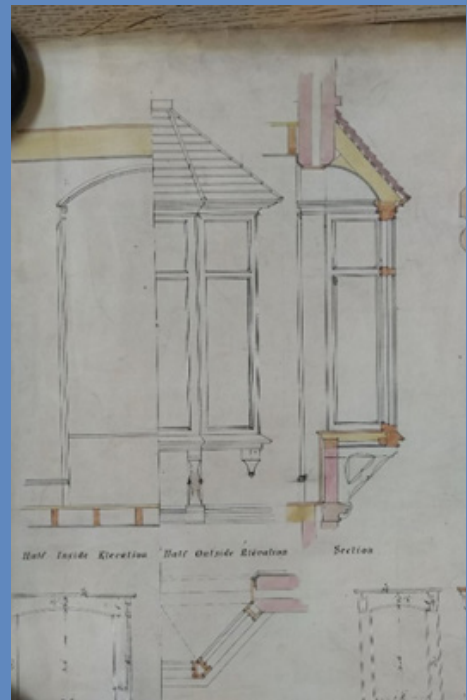

Archived plans of the first storey oriel window



Example redesign of 100 High Street



Renewal

Upper storeys redesign:

On the upper storeys the original brickwork appears in good condition. The historic bargeboard is still intact and should be repaired and retained as part of the renovation of the upper storeys. The first storey modern window looks out of sync with the rest of the building. As there is very good evidence of the oriel window that used to be on the first storey, restoring this would restore much of this building's historic Victorian character. The street lantern could be reinstalled on the corner. This would provide light in the narrow alley and a point of public interest.

Shopfront redesign:

This shopfront redesign uses the proportions of existing traditional Victorian shopfronts within the vicinity. Flexibility has been an integral part of this redesign. The side glazing of the shopfront that runs along the alleyway has been bricked up. This is more appropriate if the unit were ever needed to be used as a residential space. This redesign also shows how separate residential access can be designed into a narrow shopfront in a way that is appropriate for the conservation area.

Hub 1, Newport

101 High Street

Step 1 *Understanding your building*

Number 101 High Street Newport is not a listed building. The existing shopfront dates from the post-war years. The shopfront's deep recessed entranceway is typical of this period but makes the shopfront look dark and uninviting for passers-by to step inside.

Step 2 *Discovering your building's heritage*

Unfortunately, it has not been possible to find evidence of the pre-war shopfront design in library archives. Examples of high-quality contemporary shopfronts can be used to understand how this shopfront could be improved.

Step 3 *Assessing your building in detail*

While the recessed entrance is a significant historical feature, it is too deep for practical use. There is no significant architectural detailing on the building frontage, or any detailing shared with neighbours.

The recommended approach...

Shopfront renewal. As there are no significant architectural or historical details on the shopfront to enhance, the shopfront could be greatly improved with a design that properly frames the entrance and invites people inside.



Existing shopfront 101 High Street

No historic images
yet found

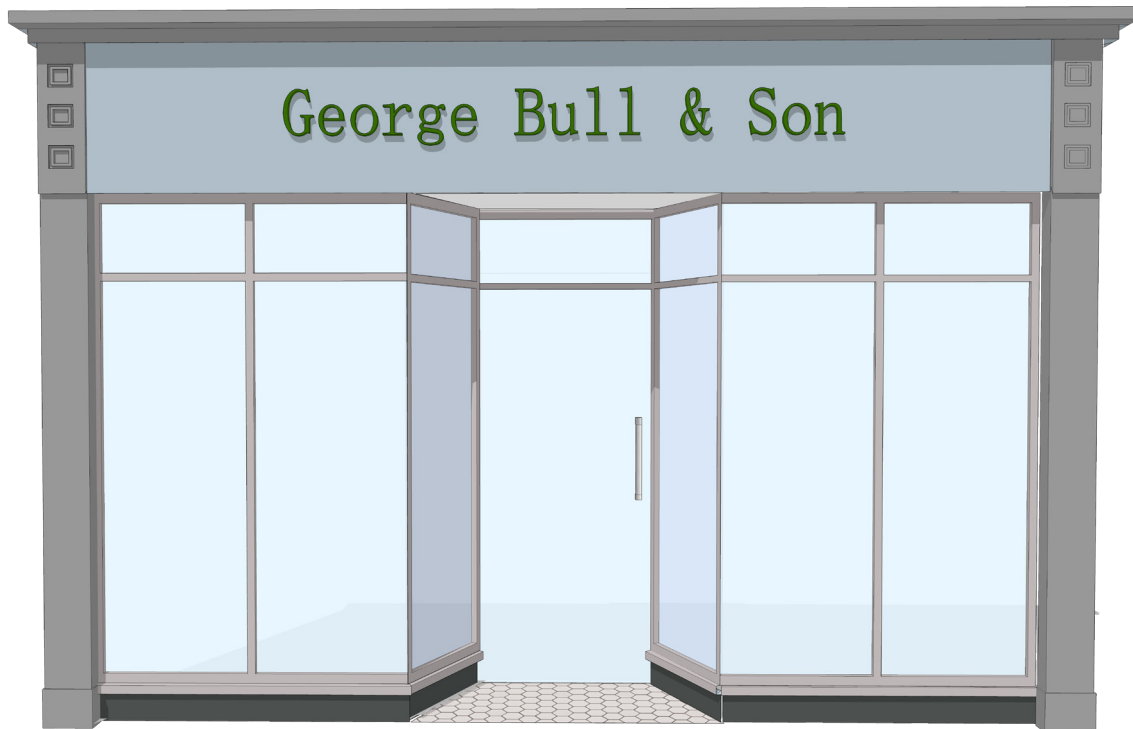

Example redesign of 101 High Street



Renewal

Upper storeys redesign:

The existing proportions of the upper storeys are in harmony with each other, with a double window on the first storey and single window on the second storey. The brickwork and paintwork on the upper storeys appears to be in good condition. No changes to the upper storeys are needed.

Shopfront redesign:

The existing fascia should be reduced for a better fit with the building's proportions and neighbouring shopfronts. As the building façade has minimal architectural detailing, a contemporary shopfront that draws inspiration from the post-war origin of the existing shopfront is most appropriate. A shallower recessed entranceway brings more natural light to the entrance. The new shopfront is properly framed with a new cornice and contemporary pilasters.

Hub 1, Newport

102 High Street

Step 1 *Understanding your building*

102 High Street is not a listed building. The existing shopfront has some great historic qualities and with some restoration of small architectural details, this shopfront could make an even greater impact on the street.

Step 2 *Discovering your building's heritage*

There is good quality evidence of the building's original shopfront in library archives in the form of technical drawings, including an elevation. Key architectural details are visible in this elevation. For example, the spheres that once sat on the pediments at the top of the pilasters, and the rounded wooden spandrels in the doors.

Step 3 *Assessing your building in detail*

Much of the frame of the original shopfront design remains intact. There are some surviving beautiful architectural details such as the pilasters and pediments. However, some of the more ornamental details are lost. The existing shopfront has separate access to the upper storeys, which gives the building flexibility.

The recommended approach...

There is a good amount of detail from the historic design that has survived, and evidence of the details that have been modified over the years. The best approach here is repair and reinstatement of those missing details to make this shopfront really shine.



Existing shopfront 101 High Street



Archived plans of historic shopfront



Example redesign of 102 High Street



Repair & Reinstatement

Upper storeys redesign:

On the first storey the historic oriel window is still intact which adds to the character of the frontage. But this window frame needs some care, in the form of a deep clean or if possible, replacement (ideally with timber window frames with slimline glazing to provide good insulation). The render on the upper storeys requires attention as it is showing cracks from natural wear and tear over time. Either repainting the render or even better, exposing the original brickwork on the upper storeys, would restore much of the building's historic character.

Shopfront redesign:

Archives show that the original pilasters are still intact, so this design focuses on restoring some of the pediments' ornamentation. The ornamental spheres that should sit on the top of the pilasters have been restored as per the historic drawings. Joinery that mirrors the historic design in the form of rounded spandrels have been added to the doors. The wooden panelling on the fascia is not consistent with the traditional feel of the shopfront and the fascia's appearance could be removed by simply removing this.

Hub 1, Newport 103 High Street

Step 1 *Understanding your building*

This building is not listed and there are a number of things that can be done to improve this shopfront.

Step 2 *Discovering your building's heritage*

In the library archives no evidence was found of the original design.

Step 3 *Assessing your building in detail*

This building and shopfront has lost most of its historic features and currently feels like a contemporary shopfront within the frame of an early 20th century shopfront. Some tiles from the 1920s-1930s remain in the place of pilasters, framing the shopfront and on the stallriser. The original cornice is also intact.

The recommended approach...

As there is little surviving historic detailing on this shopfront and the condition of the existing shopfront, renewal is the best approach. As part of this renewal, the shop's remaining historic detailing, such as the cornice and early 20th century tiles, should be retained.



Existing shopfront 103 High Street

No historic images
yet found



Example redesign of 103 High Street



Renewal

Upper storeys redesign:

There is little existing architectural detailing on the upper storeys. The window frames on the second floor give a better sense of the building's character than those on the first storey, owing to their recessed nature and sash frames. If the first storey window were to be replaced it should be replaced with, ideally timber, sash frames matching those on the second storey. The upper storey render is showing wear. It could be repainted, replaced or removed to expose the brickwork.

Shopfront redesign:

The modern shopfront with remaining early 20th century features has been redesigned to display these features and fit the conservation area. The early 20th century pilaster tiles have been retained. The original cornice has been cleaned. The new fascia is framed by the pilasters, improving the shopfront's proportions. The recessed door has been replaced and pulled forward to create more space inside the shop whilst still providing an interesting entrance. Mirroring the tiled pilasters, tiles have been incorporated on the floor of the recessed entrance.

Hub 1, Newport 104 High Street

Step 1 *Understanding your building*

104 High Street is not listed. The shopfront could be improved. This would aid both the business frontages and the street's sense of place.

Step 2 *Discovering your building's heritage*

No historic evidence of the original shopfront design for this double frontage was found in library archives.

Step 3 *Assessing your building in detail*

Like its neighbouring Card Factory, this building and shopfront has lost much of its historic charm. However, the early 20th century tiles remain intact. The original cornice is also still present but needs serious cleaning and repainting. The recessed doorways add to the shopfront's character but are in poor condition. The shopfront's fascia is too big.

The recommended approach...

The existing shopfront's proportions need to be significantly reworked. A shopfront renewal is therefore the most appropriate option. The redesign should incorporate the modest amount of remaining architectural detailing such as the tiled pilaster and the original cornice.



Existing shopfront 104 High Street

No historic images
yet found



Example redesign of 104 High Street



Renewal

Upper storeys redesign:

There is no existing significant architectural detailing on the upper storeys with which to work. The render on the upper storeys is in a relatively poor condition and could be removed to expose the brickwork or be properly replaced. The upper storeys on such a large frontage have a significant impact on the street. The render has suffered natural wear and tear and would benefit from a repaint. The window frames need some cleaning. So does the cornice at the top of the building.

Shopfront redesign:

The oversized fascia has been split into two, better to frame the double frontage. The stone stallriser has been replaced with black tiles more in keeping with the early 20th century tiles. The 'Entry' and 'Exit' signs in the fanlights above the doors have been removed and replaced with clear glass more appropriate for a conservation area and permitting more natural light into the shop. Opening transom lights also improve ventilation inside the shop.

Hub 2, Newport

Hub 2 in Newport is opposite Hub 1. These shopfronts were selected because the recommended approach for each shopfront varies greatly, producing three very distinct shopfronts that work together coherently.



Example redesign of hub 2 shopfronts, Newport



View of the existing art deco shopfront in Hub 2, Newport

Hub 2, Newport

59 High Street

Step 1 *Understanding your building*

This building is unlisted. The existing shopfront does not suit the building. It could be greatly improved to benefit the building and be more fitting to the conservation area.

Step 2 *Discovering your building's heritage*

A historic photograph found online reveals that the shopfront was originally Georgian. The photograph shows that the upper floors were a continuation of No. 60. Both shops have red bricks and lavender brick headers which are distinctive to Newport. These are now hidden on No.59.

Step 3 *Assessing your building in detail*

The existing shopfront bears no resemblance to the historic design. The existing shopfront is out of keeping with the building's upper storeys which are clearly older. Most importantly, the proportions of this frontage feel wrong. The bottom of the fascia is touching the first storey window and seems much too large for a narrow frontage.

The recommended approach...

The recommended approach for this frontage is shopfront renewal. The existing shopfront could be significantly improved. The surviving historic photograph gives a good starting point for restoring the building's historic character.



Existing shopfront 59 High Street



Historic photograph found online



Example redesign of 59 High Street



Renewal

Upper storeys redesign:

Despite evidence from the historic photograph which shows that this building once had an oriel window on the first storey, the existing first storey window has some architectural interest and need not be replaced. Nevertheless, exposing the historic brickwork and reuniting the building with the adjacent property would present an enhancement as long as this is carefully undertaken.

Shopfront redesign:

Replacing the shopfront with one which better resembles the historic design improves the street and renders the frontage more harmonious. As far as possible, a new shopfront which resembles the historic photograph is the best option. The redesign is a Georgian-inspired shopfront with a 12-panel window. This frontage could be used flexibly as either a home or a shop. The glazing can be made opaque for the former use or kept clear for the latter use.

Hub 2, Newport

60 High Street

Step 1 *Understanding your building*

60 High Street is not a listed building. However, this historic shopfront is of architectural significance and it is a noteworthy shopfront within the conservation area. Improving recent modifications would further improve the shopfront's quality and enhance its contribution to the street.

Step 2 *Discovering your building's heritage*

No evidence of the original shopfront design was found in historic archives. However, a historic photograph found online shows that the existing shopfront is not the building's original.

Step 3 *Assessing your building in detail*

In this case, attractive twentieth century features should be preserved and enhanced. Whilst this 1920s-1930s shopfront is not of the same date as the building, it was, in its time, a considerable investment of design, materials and craftsmanship. It continues to make an attractive and distinct contribution to the high street.

The recommended approach...

Repair and reinstatement of shopfront components to enhance the existing historic shopfront. Replacing a shopfront such as this to a similar standard would be a very considerable investment. It is therefore better to conserve what is present.



Existing shopfront 60 High Street



Historic photograph found online

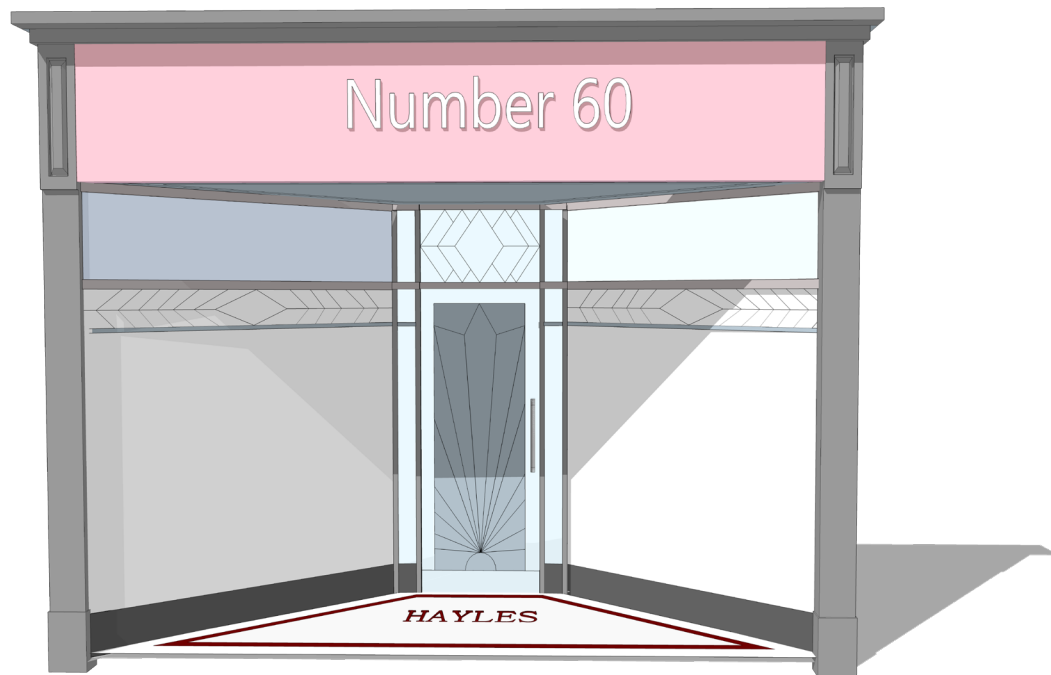

Example redesign of 60 High Street



Renewal

Upper storeys redesign:

From the historic photograph, it is evident that the lower half of the first storey window has been lost as the fascia has been extended upwards. The work to correct this would be extensive. The recommendation is therefore to keep the window as it is, unless the owner wished to restore the window to its historic state to suit their use of the inside space. The upper storeys' brickwork and windows appear to be in good condition and need not be altered.

Shopfront redesign:

The glazing, door, mullions and overall structure are unaltered. The shopfront windows are of particular significance and have been protected. The advertising stickers have been removed from the transom light. A secondary layer of glazing would improve the historic window's energy efficiency without compromising the heritage features. The existing fascia is not in keeping with either the proportions or historic design of the shopfront. Removing the oversized board fascia to see what remains underneath would be a first step. A smaller fascia framed by an appropriate cornice and simple pilasters is the focus of this design; to frame and enhance the existing beautiful shopfront.

Hub 2, Newport

61 High Street

Step 1 *Understanding your building*

This building is not listed. This shopfront could be significantly improved to restore some of the building's historic character and contribute to the historic sense of place in the conservation area.

Step 2 *Discovering your building's heritage*

There is good quality evidence of the unique original shopfront design found in library archives.

Step 3 *Assessing your building in detail*

The existing shopfront does not resemble the historic design and it would appear that none of the original shopfront design remains. (Although this should be checked first by removing the existing fascia). The existing shopfront has suffered wear and tear and certainly needs an update.

The recommended approach...

The historic design found in library archives is a unique design which, if restored, would greatly enhance the building's historic character and the street's place quality.



Existing shopfront 61 High Street

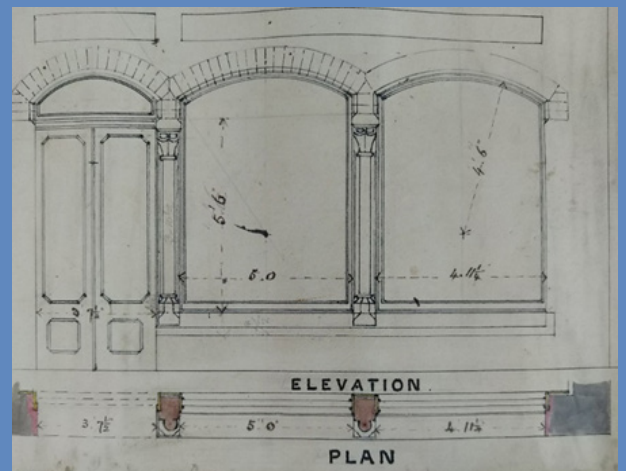

Historic design found in library archives

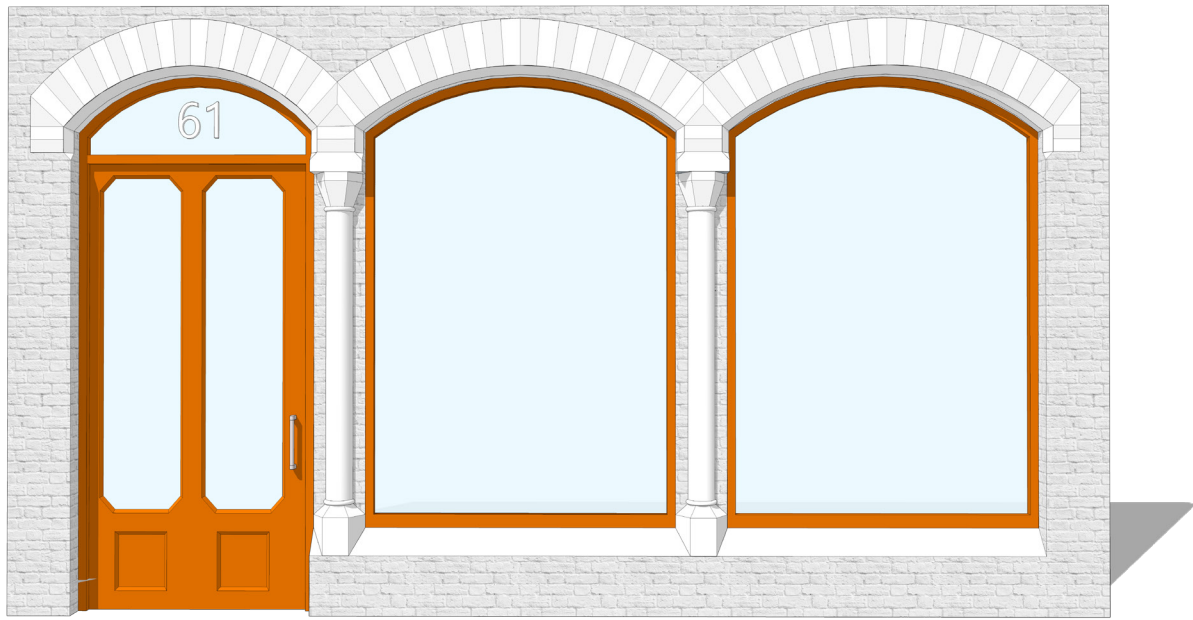

Example redesign of 61 High Street



Renewal

Upper storeys redesign:

The upper storeys appear to be in a good condition. They enhance both the building and the street. The design and materiality of the windows are all in keeping with the conservation area's sense of place. The brickwork appears to be in a good condition. No changes are needed to the upper storeys.

Shopfront redesign:

The redesign is inspired by the dimensions and arched form of the historic shopfront design. Modifications have been made to ensure that it meets modern needs. For example, the door is a faux double door, to ensure that it meets accessibility standards. By using alternative materials to the original brick, such as wood, this shopfront need not be too costly to install. However, it can still have a very positive effect on the building's frontage.

Hub 3, Newport

Hub 3 in Newport is located on the far western end of the High Street. This hub was selected for two reasons. Firstly, this area of the High Street is the first part seen by those entering from the West. These shopfronts also sit next to the historic Castle Inn pub, a significant 17th century building and local landmark. Secondly, these shopfronts all belong to the same building. They present a good opportunity to illustrate how coherent but unique designs can be used to unify a group of shopfronts without losing individual identity.

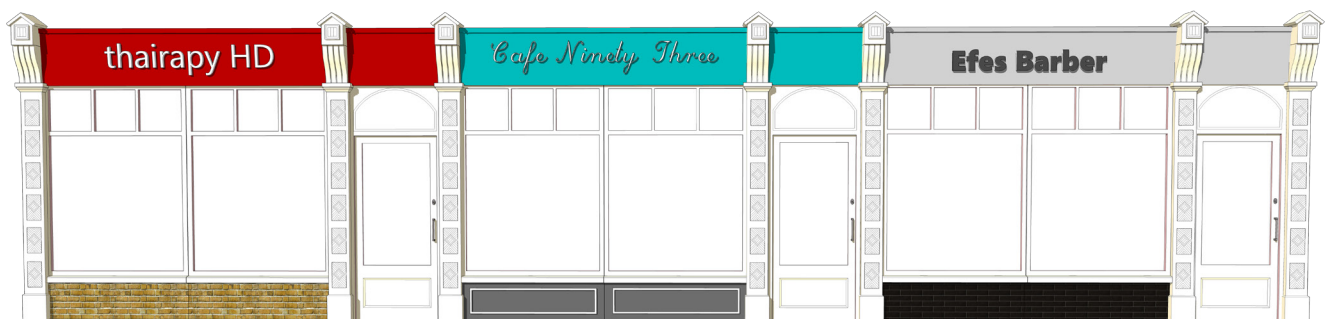
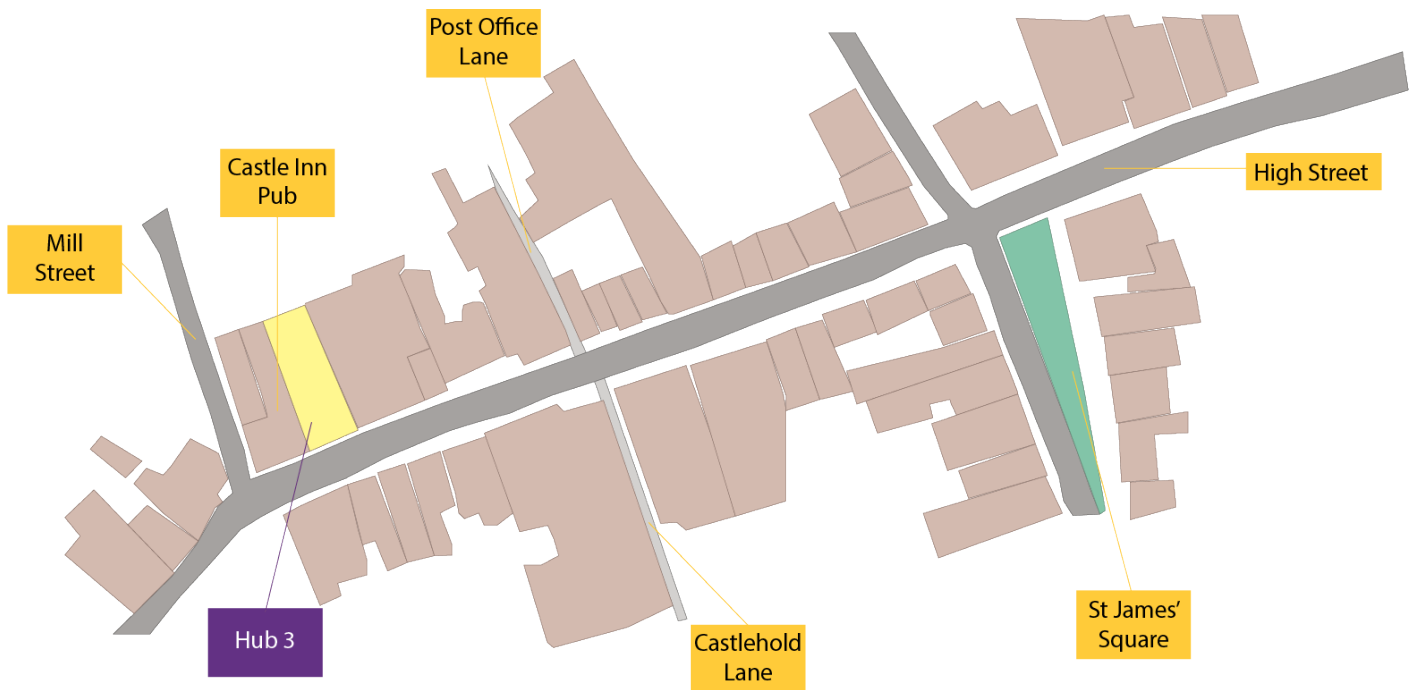

Example redesign of Hub 3, Newport



View of Hub 3 from the west



View of Hub 3 from the east

Hub 3, Newport

92-94 High Street

Step 1 Understanding your building

92-94 High Street is not listed. At present, these three shopfronts look out of sync with one another, despite belonging to the same building. Much more can be done to unify these frontages, create more impactful shopfronts and enhance the sense of place on this part of the High Street.

Step 2 Discovering your building's heritage

There is good quality evidence of the distinctive original shopfront design for all three shopfronts in library archives.

Step 3 Assessing your building in detail

The existing shopfronts bear no resemblance to the original design and none of the original design remains on any of the three frontages. The proportions of numbers 92 and 93 complement each other. However, number 94 looks out of proportion with the other frontages, and the shopfront feels too large for the size of the building.

The recommended approach...

The historic design found in library archives is a unique design which, if restored, would greatly enhance the building's historic character and the street's place quality. As the state of the upper storey interior of these shops is unclear, restoring the original design exactly is impractical. However, the original design can be used to inspire a new design.



Existing shopfronts 92-94 High Street



Historic design found in library archives



Example redesign of 92-94 High Street



Renewal

Upper storeys redesign:

The state of the first storey of this building is not clear. For this reason, the hatching detailing of the original design has been brought down into the shopfront pilasters. The upper storeys should ideally be matching in proportions across the three shopfronts. The colour of the paintwork should all be cream. The roof of the building is quite prominent on the street and an important historical feature of the building. It should be cleaned properly to ensure it is in the best possible condition.

Shopfront redesign:

The dimensions of these shopfronts should be brought into line with one another. The redesign is inspired by the historic design, rather than a direct copy. The original design features a unique 'hatching' pattern next to the first storey windows. This pattern has been incorporated into the new pilasters. This could also be done on the stallrisers combined with simpler pilasters. Alternatively, pilasters could be replaced with brickwork as in the original design. The arched window above the door has been reintroduced as in the original design. Glazing with opening transom lights have been chosen to give these shops flexibility in their future use as either shops or homes.

Hub 4, Newport

Hub 4 in Newport is located in Newport's historic St James' Square. This hub was selected because of the historic importance of this location. The individual shopfronts were chosen due to the prominence of these frontages on the public square. Because of the importance of this location in Newport, a range of historic images were available online to help understand these frontages' history.



Example redesign of hub 4, Newport



St James' Square Newport



St James' Square Newport

Hub 4, Newport

19 St James' Square

Step 1 *Understanding your building*

This building is grade II listed, meaning that it is of special interest. Every effort should be made to properly conserve it. This frontage has a big impact on the historic St James' Square. Nonetheless, modifications could be made to further enhance its impact and ensure its proper conservation.

Step 2 *Discovering your building's heritage*

Historic postcards of St James' Square show the original shopfront and upper storey's design.

Step 3 *Assessing your building in detail*

The proportions of the historic shopfront have mostly been maintained. The joinery and pilasters are a historic feature of this shopfront that should be preserved and enhanced. Contemporary modifications to this shopfront can be adjusted to be more sensitive to this listed building's heritage.

The recommended approach...

As a grade II listed building, care must be taken to repair and reinstate the historic architectural details as close to the original design as possible. This will properly enhance the building's historic character, and ensure that the frontage makes an even greater impact within the conservation area.



Existing shopfront 19 St James' Square



Historic postcard of St James' Square



Example redesign of 19 St James' Square



Repair & Reinstatement

Upper storeys redesign:

The PVC of the window frame is not appropriate for a grade II listed building and should be replaced with a timber reconstruction. The render could be changed for a softer cream colour. From historic postcards we can see that painted signs were once very prominent in St James' Square. Repainting signage directly onto the building would be a great placemaking tool. Through a survey it would be possible to find out whether the original timber frame of the building is still in a good condition below the render. If this were the case, the render could be removed to expose the original timber frame.

Shopfront redesign:

The historic postcard shows that this shopfront used to have Georgian panelled windows. This has been a focus of the redesign. The fanlight above the door should not be used for advertising. Instead the same glazing from the panelled windows has been carried across to create a more harmonious design. The box sign on the fascia has been removed and a Georgian-inspired fascia resembling the historic images has been selected. The existing door is too modern and not in-keeping with the character of the rest of the shopfront. This has been replaced for a panelled Georgian door.



Existing painted sign on the side of a nearby building in St James' Square, Newport

Hub 2, Newport

20 St James' Square

Step 1 *Understanding your building*

This building is not listed, but it is one of the most prominent buildings in St James' Square. At present the shopfront does not highlight the building's heritage, nor does it improve the historic St James' Square .

Step 2 *Discovering your building's heritage*

Historic photographs and drawings found online show that the shopfront has changed over time. We can get a good idea of some of the shopfront's original features from these images.

Step 3 *Assessing your building in detail*

The existing shopfront bears no resemblance to the historic designs and appears at odds with the upper storey's frontage. It does nothing to showcase the building's grandeur. The only significant features on this building are on the upper storeys in the delicate architectural details that frame the windows.

The recommended approach...

In this case a complete shopfront renewal is necessary. The existing shopfront does not relate to the architecturally significant building above. The upper storeys have some good qualities that enhance the street but need proper restoration.



Existing shopfront 20 St James' Square

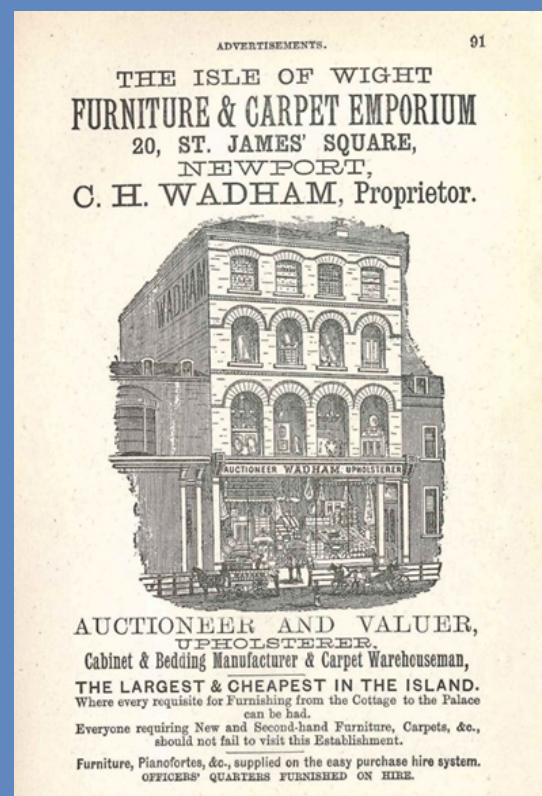

Historic drawing of 20 St James' Square as Wadham & Sons



Example redesign of 20 St James' Square



Renewal

Upper storeys redesign:

On the upper storeys, proper maintenance and returning to the original cream colour plaster would restore much of the building's lost character. It appears that there is an issue with water damage on the top floors of the building, which should be fixed as a priority. The window frames on the upper storeys are too dark and should be lightened. As the building changes use, removing vinyl stickers from the upper storey windows would greatly improve the building's appearance and create a better atmosphere on the street.

Shopfront redesign:

This redesign brings back the simple design of the tall, panelled windows and thin pilasters with angular corbels that were present when this shopfront was Wadham & Sons. The bifold doors give flexibility to this shopfront's future use as a cafe, music venue or mixed-use space where the activities can spill out onto the square. Due to this building's 'landmark' position in St James' Square, the decision not to break the large building up into smaller units was made.

Hub 2, Newport

21 St James' Square

Step 1 *Understanding your building*

This building is listed but is a prominent building within St James' Square. As a café, it encourages people to sit on the square, which contributes to the square's atmosphere. However, the shopfront itself does nothing to enhance the building or the square's heritage.

Step 2 *Discovering your building's heritage*

From historic photographs and postcards, we can see that this building has a long history as an inn and then a pub, a place for meeting and drinking.

Step 3 *Assessing your building in detail*

The existing shopfront is a could-be-anywhere contemporary shopfront that shows no evidence of the building's former status as an inn. It does not integrate well into the first storey. In particular the symmetry of the first storey and shopfront are completely at odds with one another.

The recommended approach...

This shopfront should be completely renewed. The first storey windows and cornice are distinctive features that should be highlighted by a shopfront which brings the whole building frontage into harmony.



Existing shopfront 21 St James' Square



Historic image of 21 St James' Square



Example redesign of 21 St James' Square



Renewal

Upper storeys redesign:

The first storey of the building appears to be in a good condition, although it needs some cleaning. Painting the colour of the ornamentation around the windows darker to contrast with the cream render in line with the historic design would further highlight the building's heritage and create more harmony with the shopfront redesign.

Shopfront redesign:

The focus of this shopfront redesign is to restore the building's character as a place of hospitality. In the centre of the building there once was an arch to allow horses and carriages to enter. By restoring the arch of the former entrance, the symmetry of the first storey can be mirrored on the ground floor. By using halo-lit lettering above the door, rather than a formal fascia, this retail frontage does not look like a traditional shopfront. As this is in keeping with historical records of the building, it is the preferred approach.

Hub 2, Newport

22 St James' Square

Step 1 *Understanding your building*

This building is listed. The existing shopfront feels at odds with the design of the upper storeys. The design of the shopfront could do much more to highlight the building's heritage and this part of the conservation area.

Step 2 *Discovering your building's heritage*

This building can be found in some historic postcards of St James' Square online. However, the amount of architectural detail visible in these images is limited.

Step 3 *Assessing your building in detail*

On the first storey and roof, the windows are of architectural interest, and give a sense of the building's historic character. The shopfront itself does not relate to the character of the upper storeys and the building is cut into two halves.

The recommended approach...

The best approach in this case is shopfront renewal. Through a complete redesign, an improved shopfront will do much more to highlight the building's heritage and make this building more appropriate for the conservation area.



Existing shopfront 22 St James' Square



Nationwide branch in Kendal conservation area



Nationwide branch in Richmond conservation area



Example redesign of 22 St James' Square



Renewal

Upper storeys redesign:

Use of existing features as a guideline for modifications is good conservation practice. The windows have a good sense of symmetry, are appropriate for the building and the conservation area context. The black guttering down the centre of the building cuts the frontage into two halves and should be moved to the building's left side. The pitched roof is prominent and should be properly cleaned and maintained to ensure its longevity and the building's sense of heritage.

Shopfront redesign:

This redesign aims to restore the building's symmetry and integrate the shopfront into the upper storeys. As is the case with other Nationwide branches in conservation areas, coloured lettering, rather than coloured fascias are preferable. The door on the left of the shopfront can provide access to the upper storeys. The double panelled door is most secure for a bank. The windows bring plenty of natural light inside like the existing design. However this more coherent design feels like a shopfront designed with the whole building frontage in mind.

5.2 Ryde Example Designs

Hub 1, Ryde

Hub 1 in Ryde is located at the north end of the High Street. St Thomas' Square acts as an interchange between Union Street to the north and the High Street to the south. This area is the 'gateway' to the High Street when approaching from the waterfront. The challenge this area faces is encouraging pedestrians to make the journey up the hill to the High Street.

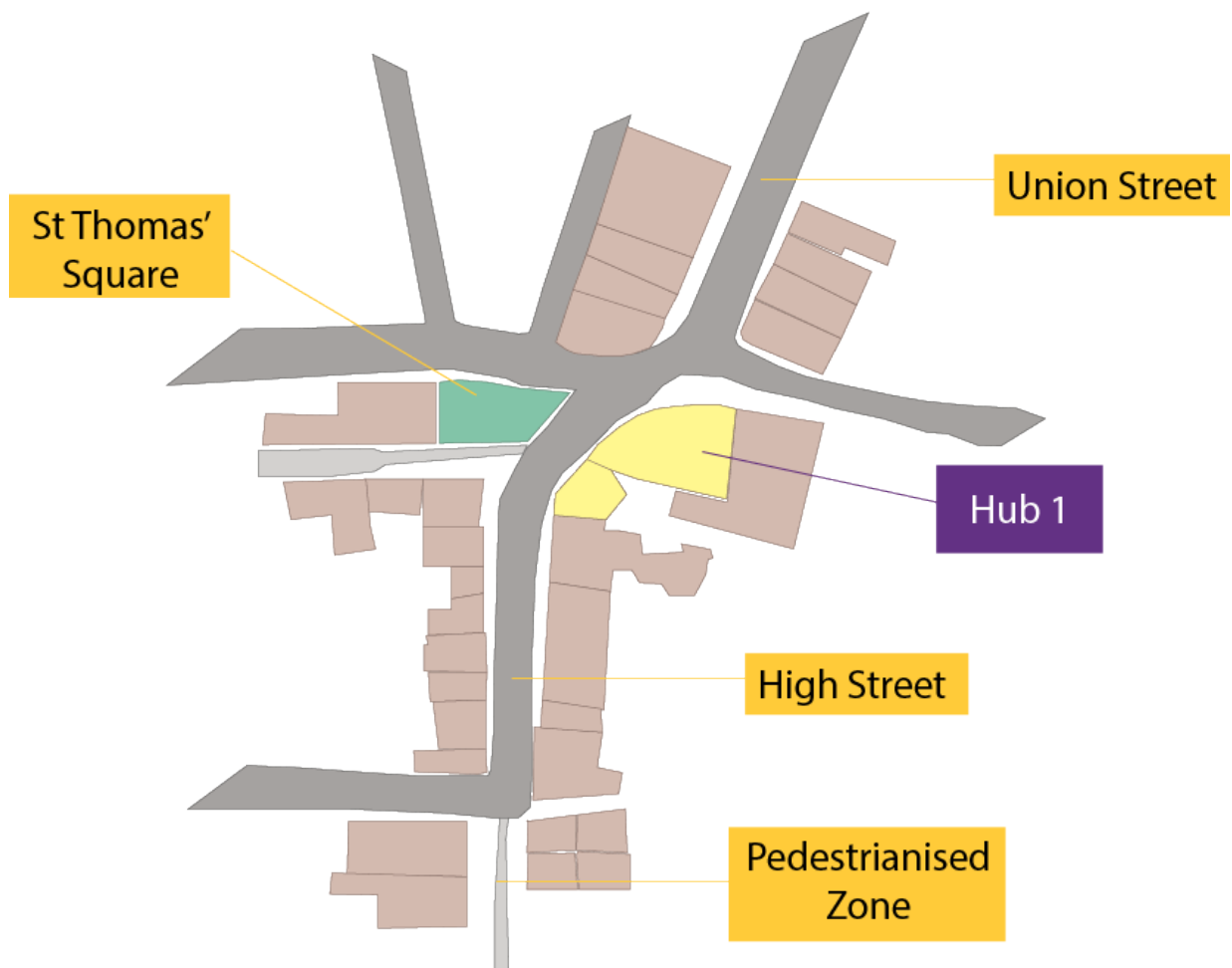

Example redesign of hub 1, Ryde



View of Ryde High Street from St Thomas' Square



View of St Thomas' Square from Union Street

Hub 1, Ryde

4 St Thomas' Square

Step 1 *Understanding your building*

This building is listed. The building has a prominent frontage on the corner of St Thomas' Square, at the bottom of the High Street where it meets Union Street. The curved building frontage attracts the eye.

Step 2 *Discovering your building's heritage*

A photograph provided by a local resident shows the mid-20th century shopfront before it underwent some later modifications.

Step 3 *Assessing your building in detail*

The mid-20th century shopfront still appears to be in a good condition, although some of the original ornamental features have been lost. The oversized fascia is a distinct part of the design that speaks to the heritage of the building and shopfront.

The recommended approach...

By restoring and reinstating as much of the original design that has been lost as possible, this shopfront will be restored to its former glory.



Existing shopfront 4 St Thomas' Square



A photograph taken on Union Street in 1967 shows 4 Thomas Square's shopfront in the background. Photo by John Cole ©.

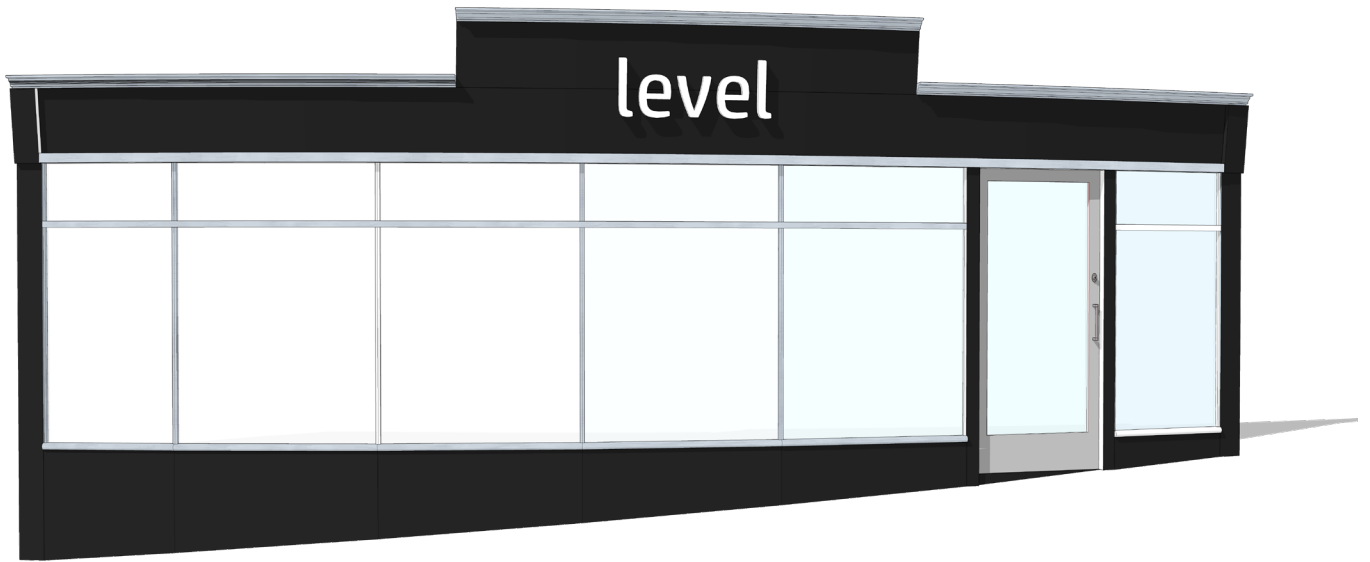

Example redesign of 4 St Thomas' Square



Cosmetic Refresh

Upper storeys redesign:

The upper storeys appear to be in a reasonable condition. Restoring the paintwork and cleaning the cornice would have a great impact on the building's frontage. The middle window on the first storey has been modified due to the height of the oversized fascia. This is now part of the building's architectural history and should not be changed.

Shopfront redesign:

In this case, an oversized fascia is acceptable, as it is part of the history of the shopfront. The stallriser can stay black. Despite the historic photograph showing a lighter colour stallriser. Our consultation has found that the community believe (not unreasonably) that lighter stallrisers look dirty more quickly than dark ones. The advertising should be removed from the transom lights. The lettering on the fascia should all be one colour, in this case, silver.

Hub 1, Ryde

5 St Thomas' Square

Step 1 *Understanding your building*

This building is not listed. The shopfront has some interesting attributes. However, with some modifications it could be more impactful.

Step 2 *Discovering your building's heritage*

A historic photograph found online (partially) shows the shopfront and first storey of the building.

Step 3 *Assessing your building in detail*

It is unclear the extent to which the existing shopfront resembles the historic photograph, owing to the quality of the image. The existing shopfront is well proportioned and is mostly appropriate for the conservation area. The original window design on the upper storeys is intact and a unique feature of this building. However, the upper storeys need some attention to restore them to their former glory.

The recommended approach...

Given the overall positive condition of the existing shopfront, the best approach is to clean up the shopfront, making minor changes to its appearance to improve the overall quality of the finish.



Existing shopfront 5 St Thomas' Square



Historic photograph of 5 St Thomas' Square



Example redesign of 5 St Thomas' Square



Cosmetic Refresh

Upper storeys redesign:

Due to its location at the start of the High Street and curved position on an incline, the upper storeys are very prominent. They need to be properly restored. Ideally, the PVC window frames should be replaced with timber reproductions. However, this may be costly. At minimum, the window frames should be made narrower, in closer proportions to the original windows in the historic design. The render is also in a poor condition and should be cleaned and repainted in the same cream colour.

Shopfront redesign:

The fascia has been brought down away from the first storey. The existing 3D lettering on the sign has been replaced with a hand painted sign. This is more in keeping with the design of the shopfront and the character of the conservation area. Advertising should be removed from the transom lights, but the advertising in the main windows is not overpowering. It is in keeping with the historic use of similar advertising in the local area. The existing shopfront appears to already provide access to the upper storeys. This should be preserved as a top priority as it gives the whole building more flexibility.

Hub 1, Ryde

9 St Thomas' Square

Step 1 *Understanding your building*

9 St Thomas' Square is not listed. The existing shopfront has a negative impact on the street as it contributes to the number of blank façades and empty windows in the area.

Step 2 *Discovering your building's heritage*

A historic photograph found online shows that this building was once home to three individual shops.

Step 3 *Assessing your building in detail*

The existing shopfront does not resemble the historic design. The first storey oriel windows are surviving significant architectural features. On the shopfront itself there are no significant architectural features.

The recommended approach...

This shopfront should be completely redesigned. There is nothing about the existing shopfront that should be conserved. A new shopfront would greatly enhance the building's heritage and the sense of place in this important part of the conservation area.



Existing shopfront 9 St Thomas' Square



Historic photograph of 9 St Thomas' Square showing that this building was originally divided into three separate units.

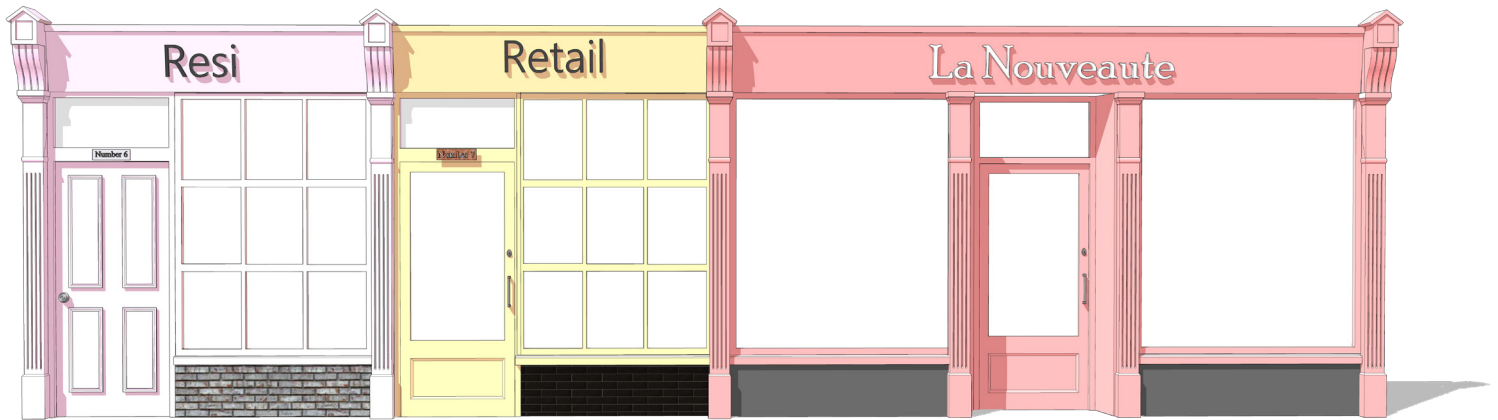

Example redesign of 9 St Thomas' Square



Renewal

Upper storeys redesign:

The first storey needs cleaning and repainting in either cream or off-white. When the window frames are due to be replaced, timber frames should ideally be used. The window frames should be narrowed to match the proportions of the historic design.

Shopfront redesign:

As these premises are currently unoccupied, splitting the frontage into multiple units is both in-keeping with the building's historic use and restores flexibility for a mix of future residential and retail uses. The ground floor bay window has already been lost. One option would be to rebuild this. However, this would be expensive. Introducing ground floor residential access where the left-hand side bay window once stood is a better use of funds. All three units complement one another in their matching proportions and pilasters, but each unit could be varied in terms of the stallrisers and colour of the frontage to give more variety.

Hub 2, Ryde

Hub 2 in Ryde is located towards the north end of the High Street in the centre of the pedestrianised area. It is comprised of three modest contemporary shopfronts for which little historical evidence was found to inform their redesigns. This hub was selected to illustrate how contemporary shopfronts and modest frontages can be improved through careful design.

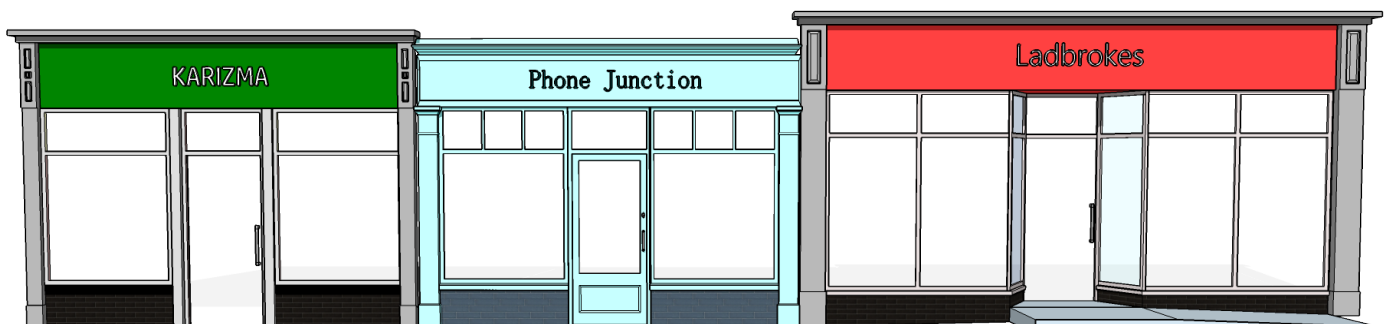
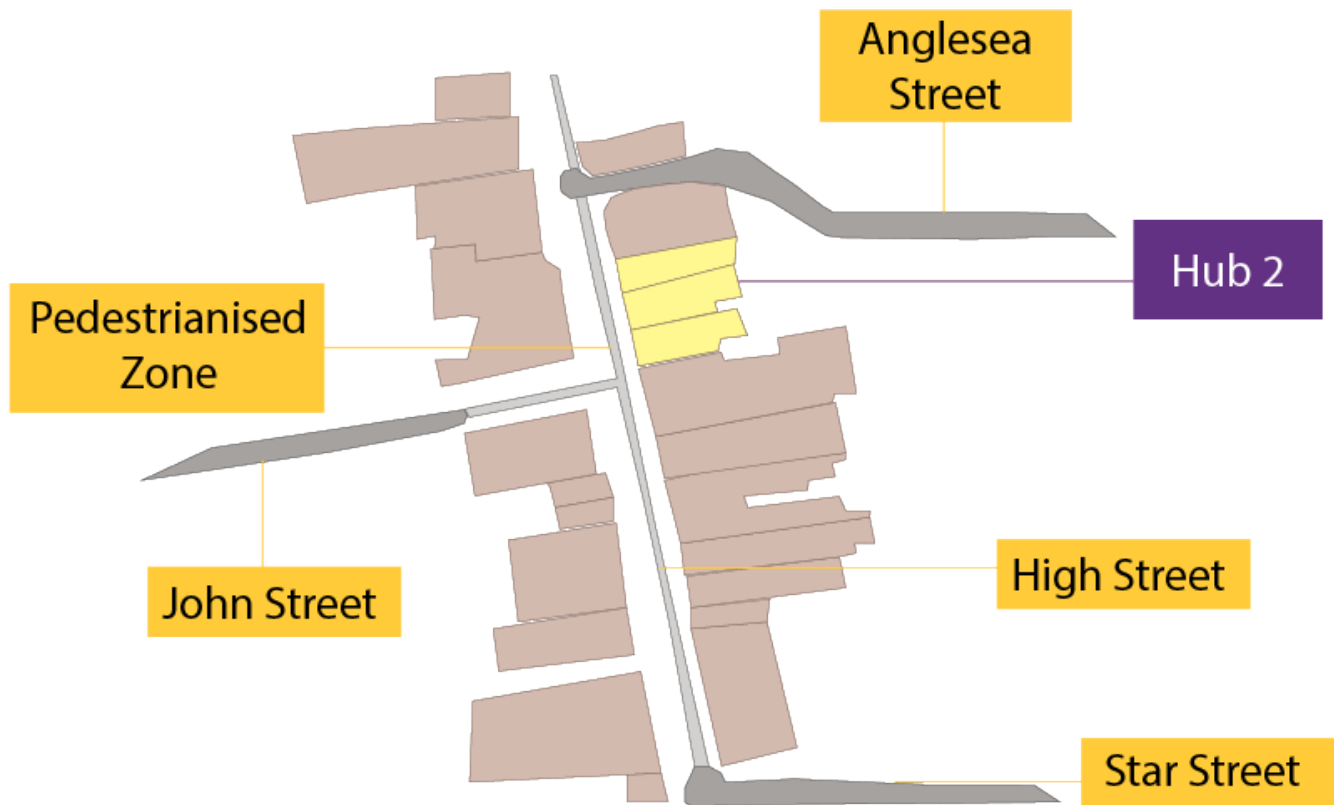

Example redesign of hub 2, Ryde



Centre of pedestrianised High Street



Hub 2 Ryde Shopfronts

Hub 2, Ryde 25 High Street

Step 1 *Understanding your building*

25 High Street is not a listed building. The existing shopfront shows an active frontage, which contributes to the sense of place on the street. However, improvements could be made to better unify the frontage and improve the conservation area's historic sense of place.

Step 2 *Discovering your building's heritage*

There was no evidence found online or in library archives showing what this building used to be or how it looked.

Step 3 *Assessing your building in detail*

This building is difficult to date, as it has lost much of its historic character. The large cornice on the first storey is a significant architectural detail that adds to the building's sense of character.

The recommended approach...

The existing shopfront is not properly framed. Adding a frame would greatly enhance this shopfront, therefore a shopfront renewal is the best route. Due to the absence of heritage features on this frontage, a contemporary design is most appropriate.



Existing shopfront 25 High Street

No historic images
yet found



Example redesign of 25 High Street



Renewal

Upper storeys redesign:

On the first storey, it is possible that the original lintels are still intact underneath the render. If so, exposing them would be a good way to bring back some of the building's character. Otherwise, the modest first storey appears to be in a reasonable condition and need not be altered.

Shopfront redesign:

This contemporary redesign is similar to other contemporary shopfronts in the surrounding area in terms of proportions and characteristics. On a modest, simple shopfront a brighter colour palette (not garish) can be more easily used, which is something that the public support. This redesign has properly framed the shopfront with simple pilasters, a cornice and stallrisers. The box sign has been replaced with a traditional fascia board, to better display the business name in a way appropriate for the conservation area.

Hub 2, Ryde 26 High Street

Step 1 *Understanding your building*

This is not a listed building. The existing shopfront feels at odds with the first storey of the building and is not consistent with the historic character of the conservation area.

Step 2 *Discovering your building's heritage*

No evidence was found online or in library archives showing this building's historic use or shopfront design.

Step 3 *Assessing your building in detail*

Like its neighbour, 25 High Street, this building has lost much of its historic character. The shopfront itself feels temporary and has no significant historic features. On the first storey the windows and cornice appear to be Georgian in character and are of some architectural interest.

The recommended approach...

A new shopfront which frames and enhances the existing architectural details on the first storey is the best approach.



Existing shopfront 26 High Street

No historic images
yet found

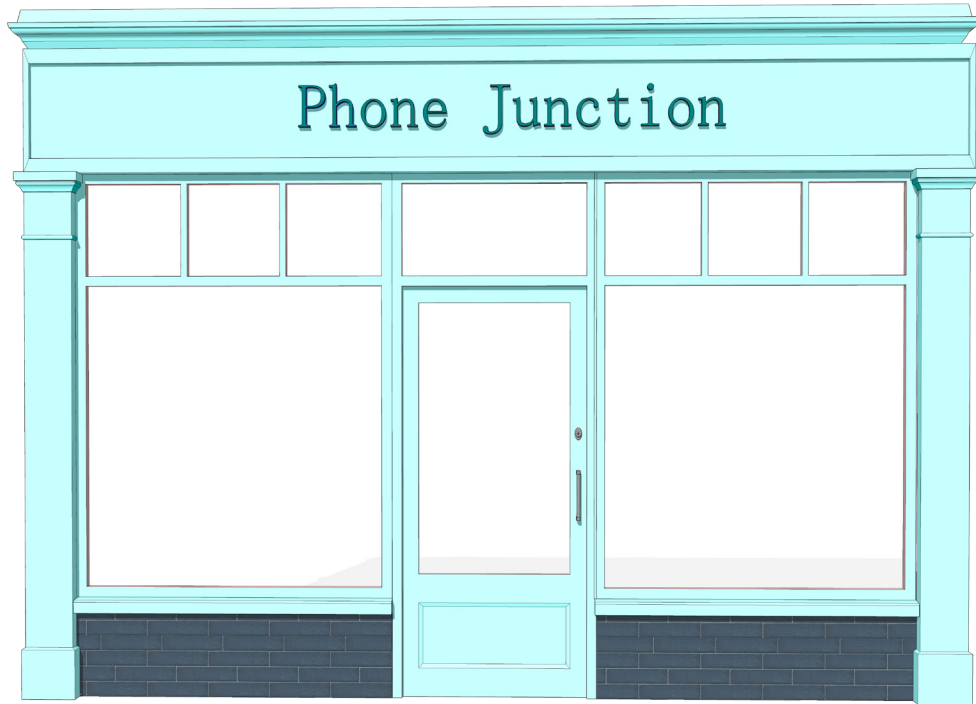

Example redesign of 26 High Street



Renewal

Upper storeys redesign:

On the first storey there appears to be some nails protruding from the wall. These should be removed and if possible, the electronic alarm better concealed.

Shopfront redesign:

For this shopfront replacement a Georgian shopfront has been chosen to complement the first storey's panelled windows. As this shopfront hub is made up of buildings for which no historic records have been found and minimal historic features are remaining, a gently colourful palette would work.

Hub 2, Ryde 27 High Street

Step 1 *Understanding your building*

This building is not listed. The existing shopfront could be improved to better enhance the sense of place on the street.

Step 2 *Discovering your building's heritage*

There was no available evidence online or in library archives showing what this building used to be or the original shopfront design.

Step 3 *Assessing your building in detail*

This building frontage has no significant definable historic features.

The recommended approach...

The best approach in this case is shopfront renewal in a contemporary design that uses the proportions of existing quality contemporary shopfronts in the local area as precedent.



Existing shopfront 27 High Street

No historic images
yet found



Example redesign of 27 High Street



Renewal

Upper storeys redesign:

The upper storey has no significant historic features that can be enhanced. The render should be repainted. If possible, removing the render to expose the brickwork would give the building more architectural interest. The window frames are in disrepair and should be replaced, preferably with timber, keeping the same proportions of the existing window frames.

Shopfront redesign:

This building does not have any definable historic features that can be used for developing a heritage-focused design. The shopfront has been framed by new pilasters and cornice. The ramp is a possible solution to the step into the shop, improving access in an area of the high street that is pedestrianised. But the Highways team should be consulted on an access solution that complies with regulations.

Hub 3, Ryde

Hub 3 in Ryde is located in the centre of the pedestrianised area of the High Street. The frontages in this hub face John Street, which has a small public square and acts as a node for social interaction. For users of this public space the appearance of the frontages in Hub 3 make a great impact. Due to this hub's location in the centre of the pedestrianised area, different types of access and awnings can be explored.

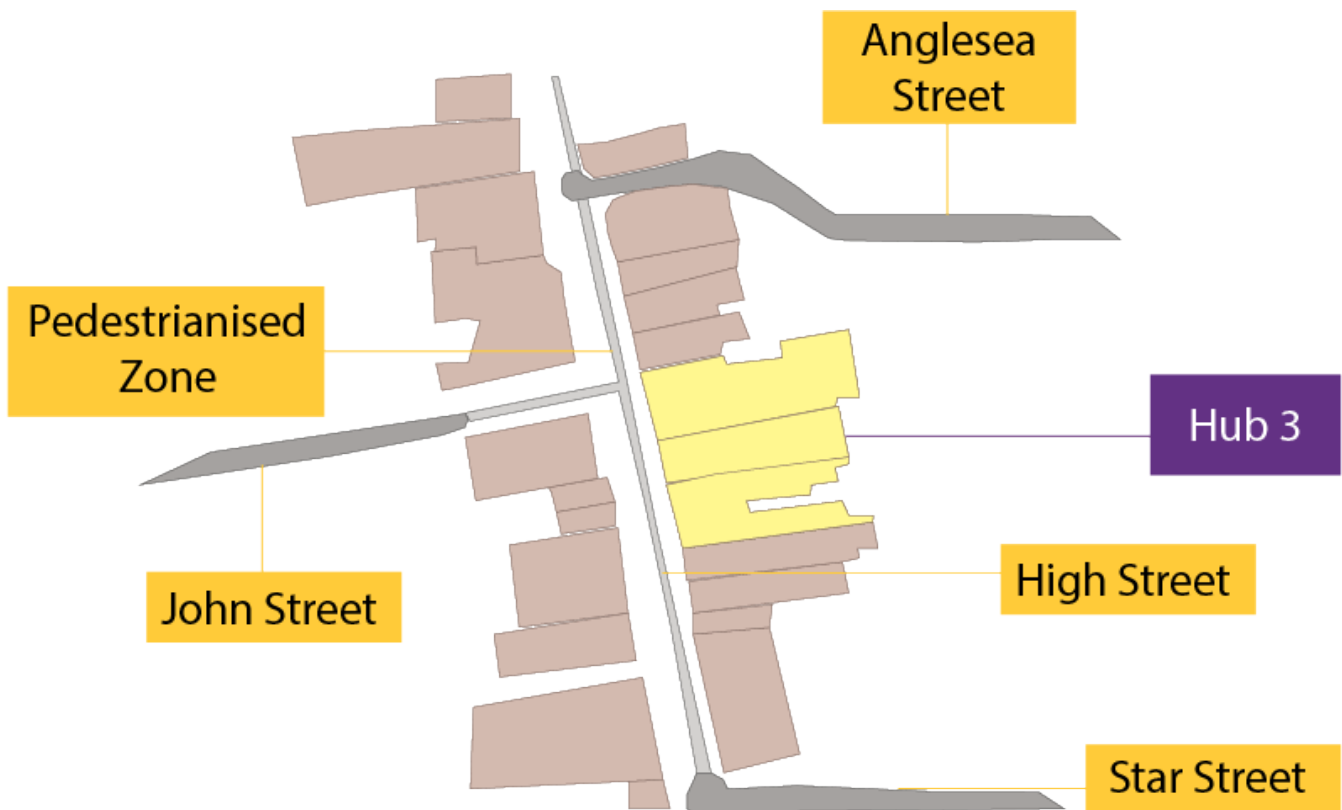

Example redesign of Hub 3, Ryde



Hub 3, Ryde



Public square, John Street

Hub 3, Ryde

28 High Street

Step 1 *Understanding your building*

This building is not listed. The existing shopfront does does improve the street, with an active frontage that brings life onto the street. However, more can be done to highlight the building's heritage.

Step 2 *Discovering your building's heritage*

There was no available evidence online or in library archives showing this building's historic frontage.

Step 3 *Assessing your building in detail*

By looking at the architectural detailing on the first storey we can see that this is a Victorian building. At present this Victorian heritage is only reflected in the upper storey and the building appears to be split in the middle.

The recommended approach...

A full shopfront renewal would provide an opportunity to design a shopfront that better integrates with the Victorian architectural details on the first storey.



Existing shopfront 28 High Street

No historic images
yet found



Example redesign of 28 High Street



Renewal

Upper storeys redesign:

The upper storey of the building appears to be in a good condition. The original oriel window has been properly maintained and only shows normal signs of wear and tear. The black gloss paint looks out of place on a Victorian building and these details should be repainted in a non-gloss paint

Shopfront redesign:

The existing Dutch blind on this shop is not historically accurate according to photos of this area from the early 1900s. In the redesign this has been replaced with a canopy that will provide the same positive effects of a Dutch blind but sit better with the building's historical features. With a set-back entrance, it is possible to contain an access ramp within the shopfront itself. This redesign has brought down the language of the ornate Victorian upper storey into the shopfront design through traditional Victorian pilasters and a cornice that better frames the fascia.

Hub 3, Ryde

29 High Street

Step 1 *Understanding your building*

29 High Street is not a listed building. The existing shopfront feels disconnected from the upper storey. This shopfront can be greatly improved to better reflect the building's heritage and improve the business frontage.

Step 2 *Discovering your building's heritage*

There was no available evidence online or in library archives showing this building's historic frontage.

Step 3 *Assessing your building in detail*

By looking at the architectural detailing on the first storey we can see that this is a Victorian building. At present this Victorian heritage is only reflected in the upper storey and the building appears to be split in the middle.

The recommended approach...

A full shopfront renewal could create a shopfront that better integrates with the Victorian details on the first storey to be designed. This would give the business more impact on the street and make the shopfront a point of public interest.



Existing shopfront 29 High Street

No historic images
yet found



Example redesign of 29 High Street



Renewal

Upper storeys redesign:

The surviving Victorian architectural features should be properly repaired and repainted. The bottom of the oriel window should be cleaned to protect the wood. The brickwork should be repainted as it has suffered natural wear and tear over time.

Shopfront redesign:

This shopfront redesign is Victorian inspired as this is a Victorian building. A recessed shopfront gives the business more window space to display clothing. This design was developed according to research into recessed Victorian shopfronts. Narrow broom pilasters frame the recessed entrance. The shopfront itself is framed by paneled pilasters which are consistent with similar ornamentation in the local area, and the business' branding.

Hub 3, Ryde

30-31 High Street

Step 1 *Understanding your building*

This building is not listed. The existing shopfront is a generic contemporary shopfront that does not relate to the heritage of the building it occupies. The large vinyl stickers in the windows create a blank façade and have a negative impact on the street.

Step 2 *Discovering your building's heritage*

There was no evidence found online or in library archives showing this building's historic frontage.

Step 3 *Assessing your building in detail*

By examining the architectural detailing on the first storey we can see that this is a Victorian building. The oriel windows, engaged pilasters, and ornate cornice are significant architectural details that should be enhanced.

The recommended approach...

A full shopfront renewal would better integrate with the Victorian details above. This should illustrate how corporate chains can work with historic buildings to create beautiful shopfronts that are good for business and good for the local area.



Existing shopfront 30-31 High Street

No historic images
yet found



Example redesign of 30-31 High Street



Renewal

Upper storeys redesign:

The upper storey appears to be in a good condition and doesn't require any major changes. Proper cleaning and maintenance of the oriel windows is required to ensure the longevity of these features.

Shopfront redesign:

A Victorian shopfront can be confidently reinstated, by examining the architectural details on the upper storey. The ornamental features on the first floor (such as panelling) have been used on the stallrisers to create continuity in the design. At present, the glazing on the left of the shopfront is covered in advertising is not appropriate for a conservation area. This redesign could have clear or opaque glazing for more privacy on the left side as desired. New access to the upper storeys has been designed to give the building more flexibility for both residential and retail use.

Hub 4, Ryde

Hub 4 in Ryde is located on the south of the High Street. This area is not pedestrianised and faces challenges in attracting footfall. The shopfronts in this hub were selected because of their contrasting yet significant architectural designs. For all of these shopfronts historic evidence of original designs were used.

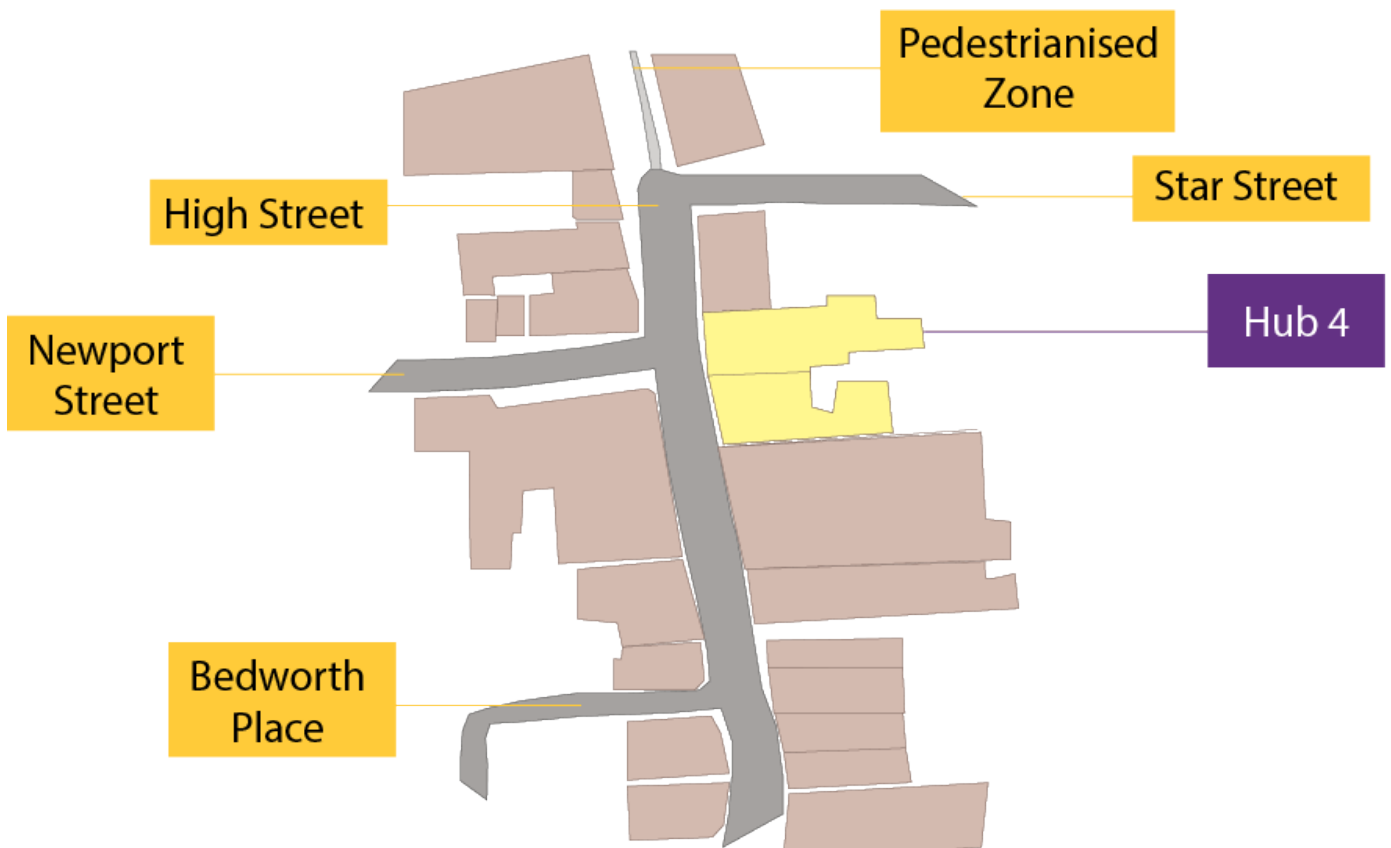

Example redesign of Hub 4, Ryde



Centre of Hub 4, Ryde

Hub 4, Ryde

43 High Street

Step 1 *Understanding your building*

43 High Street is not a listed building. The existing shopfront tells a story of the building's heritage. However, wear and tear has damaged the shopfront over time. Changes can be made to improve the building's impact on the street and restore its heritage.

Step 2 *Discovering your building's heritage*

From a historic photograph found online it is clear that this shopfront has long had an oversized fascia.

Step 3 *Assessing your building in detail*

The oversized fascia and redbrick are significant 20th century details that should be protected and enhanced in any shopfront redesign.

The recommended approach...

To restore this shopfront to its former glory, repair and reinstatement of lost architectural details is the best approach.



Existing shopfront 43 High Street

No historic images
yet found

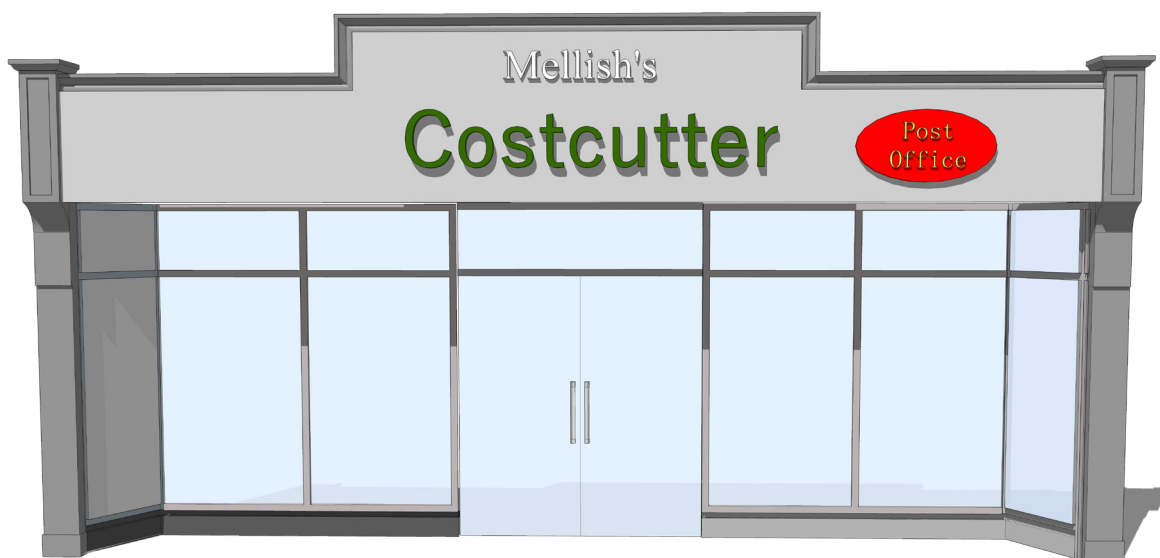

Example redesign of 43 High Street



Repair & Reinstatement

Upper storeys redesign:

The brickwork and windows on the first storey appear to be in a good condition. No changes are needed to the upper storey.

Shopfront redesign:

The oversized fascia is a part of this shopfront's history and as such, it should be protected and enhanced. The original pilasters of this shopfront are in great disrepair, with missing pediments. At present this shopfront is suffering from clutter. Many signs compete for attention and the treatment of the recessed glazing with head-to-toe vinyl advertising is not attractive. Removing much of this advertising and simplifying the signage within the frame of a restored cornice and pilasters greatly improves this shopfront.

Hub 4, Ryde

44-45 High Street

Step 1 *Understanding your building*

44-45 High Street is not a listed building. The existing shopfronts are at odds with the ornate design of the first storey. The shopfronts feel flat and uninteresting by comparison with what is above.

Step 2 *Discovering your building's heritage*

A historic photograph found online shows that the unique historic shopfront design was very ornate.

Step 3 *Assessing your building in detail*

The existing shopfronts do not resemble the historic design. They have no ornamentation or architecturally significant details that should be preserved.

The recommended approach...

A shopfront renewal based on the original shopfront design would greatly improve this historic building frontage as a whole and restore an area of public interest in this area of the High Street.



Existing shopfronts 44-45 High Street



Historic design of 44-45 High Street



Example redesign of 44-45 High Street



Renewal

Upper storeys redesign:

On the upper storeys the focus should be on restoring the oriel windows and ornamentation to their full potential. The wood should be treated and properly repainted.

Shopfront redesign:

These shopfronts belong to the same building and their redesigns reflect this. As much as is practical, the shapes and details of the historic design have been restored in this shopfront redesign. The historic design is unique in its structural form that stands out, proud from the building. This may be too costly and impractical to create today, but the shapes of the historic pediments, pilasters and oculi fanlights above the doors bring back much of the lost historic character.

Hub 5, Ryde

Hub 5 in Ryde is located at the southern end of the High Street. This area of the High Street faces challenges in terms of vehicle movement as it is no longer part of the pedestrianised zone. There is an increasing number of residential conversions, some of which are poor quality and detract from the High Street character. This hub was chosen to illustrate how flexible residential conversion can be achieved without losing the High Street character.

The shopfronts that make up this hub share different characteristics. They were chosen to illustrate how to unite shopfronts by their shared details whilst retaining their individual identity.

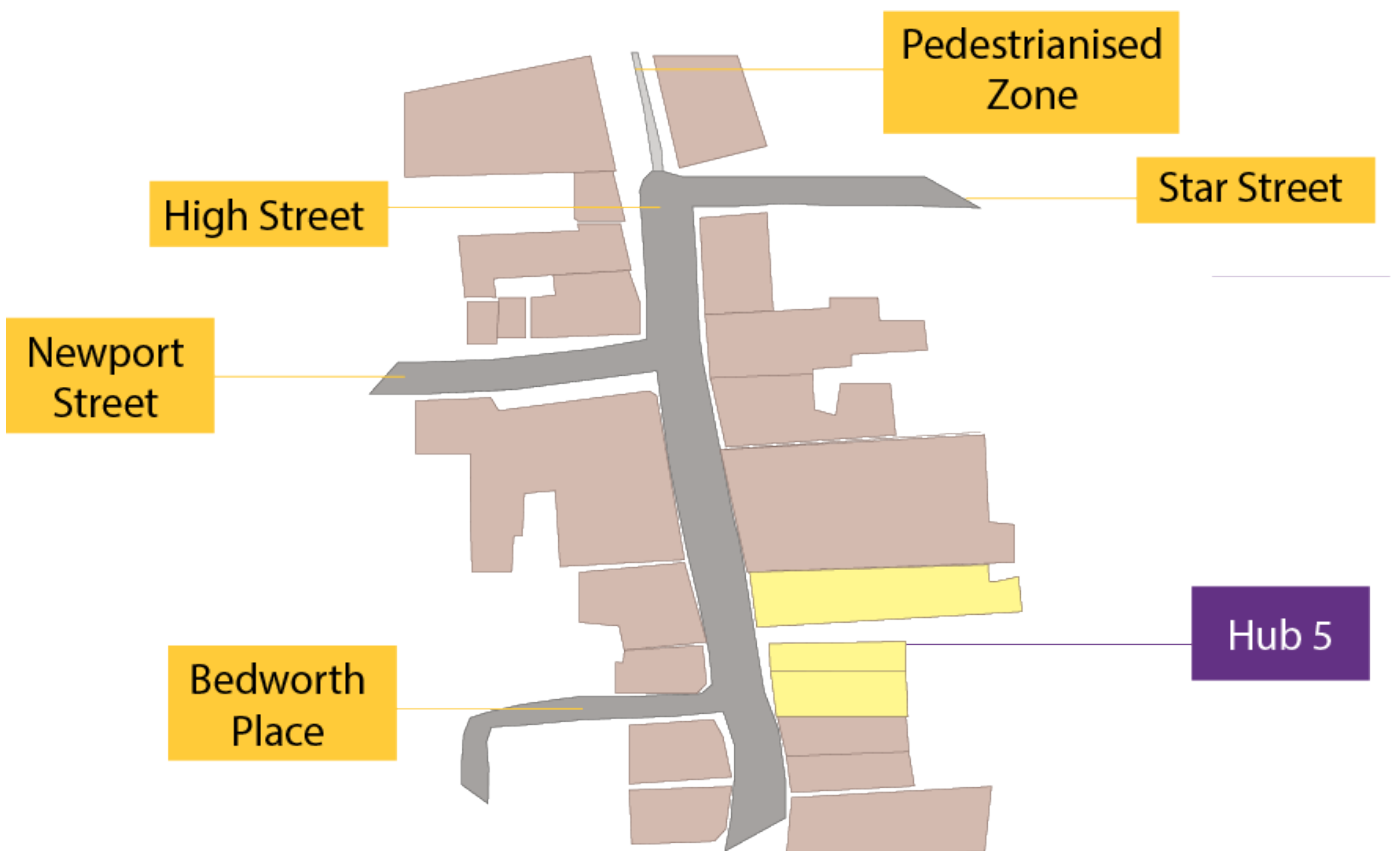

Example redesign of Hub 5, Ryde



View of Hub 5, Ryde, from the south



View of Hub 5, Ryde, from the north

Hub 5, Ryde 49 High Street

Step 1 *Understanding your building*

This building is not listed. Changes can be made to improve the shopfront's appearance and enhance the building frontage as a whole.

Step 2 *Discovering your building's heritage*

No evidence was found online or in library archives showing this building's historic frontage or use.

Step 3 *Assessing your building in detail*

This building is an eclectic mix of historic features and modern modifications. The most significant architectural details on the building frontage are the tiles which appear to date from the mid-20th century. The hanging 'café' sign on the first storey adds a point of interest. On the first storey an ornate cornice frames the top of the building nicely.

The recommended approach...

Working with some of the existing architectural details such as the tiles, the best approach is repair and reinstatement of shopfront components that will complement the existing architectural details and bring harmony to the building frontage.



Existing shopfront 49 High Street

No historic images
yet found

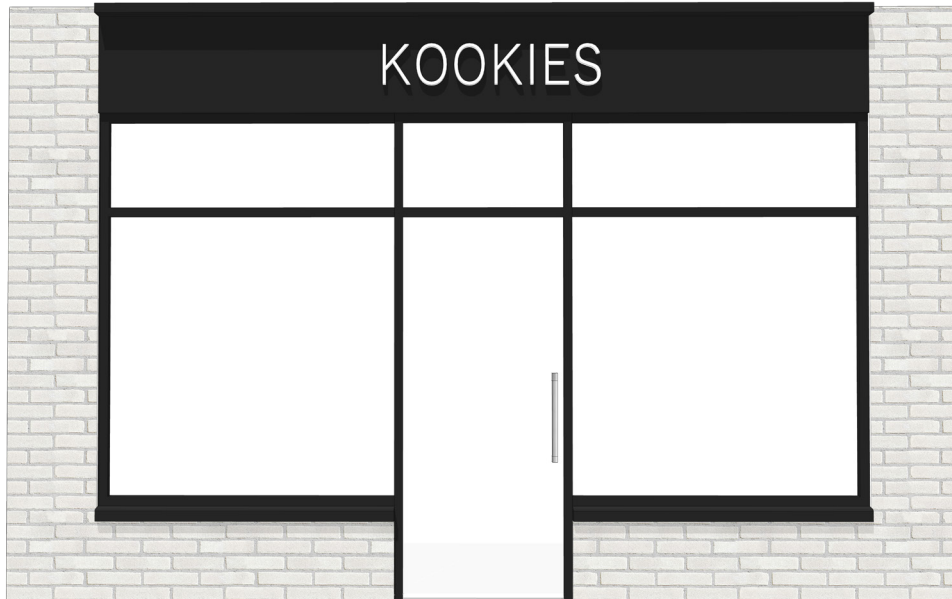

Example redesign of 49 High Street



Renewal

Upper storeys redesign:

On the upper storey, the glazed brick could be extended upwards to cover the whole building elevation. This would create more harmony between the different storeys. The window frames on the first storey would ideally be replaced with timber frames and made narrower to better match the proportions of other historical window frames in the conservation area.

Shopfront redesign:

The glazed brick on the stallrisers and pilasters add to the character of this shopfront and have been preserved in the redesign. Simple glazing and a smaller fascia have been chosen to simplify the shopfront and create a calm, inviting atmosphere for the café.

Hub 5, Ryde 50 High Street

Step 1 *Understanding your building*

This building is not listed. The existing shopfront makes the best of a simple frame and modest amount of historical detail. However, it could do more to showcase the goods on offer and the heritage of the local area.

Step 2 *Discovering your building's heritage*

No evidence was found online or in library archives showing this building's historic frontage. However, one image was found which shows the presence of an oriel window on the first storey.

Step 3 *Assessing your building in detail*

This building shares details with the building next door at 51-52 High Street. Shell details in their pediments are featured on a number of buildings in this area. This building once had an oriel window on its first storey, like 51-52 High Street.

The recommended approach...

A shopfront renewal that incorporates the small surviving architectural details on the shopfront is the best approach.



Existing shopfront 50 High Street



Historic postcard showing upper storey oriel window for 50 High Street in the distance



Example redesign of 50 High Street



Renewal

Upper storeys redesign:

Reinstating the first storey oriel window would restore much of the building's character but would be costly. The PVC window frames should ideally be replaced with timber. The render and paintwork need some care as they have suffered from natural wear and tear. The hanging sign is a nice touch that should be preserved.

Shopfront redesign:

Because of the relationship with its neighbouring building, the historic image of 51-52 High Street has been used to inspire 50 High Street's shopfront design. Due to the location of these shopfronts at the southern end of the High Street, where there are fewer shops and more homes, the shopfront designs are intended to be flexible and to function as either homes or shops. Were this unit to become a home, adding opaque glazing would give residents more privacy. Opening transom lights makes temperature regulation easier.

Hub 5, Ryde 51-52 High Street

Step 1 *Understanding your building*

This building is not listed. The existing shopfront neither looks like a shopfront nor a private residence. There are a number of things that can be done to greatly improve the building frontage.

Step 2 *Discovering your building's heritage*

Very clear evidence of the original shopfront design was found online. This image shows that 52 High Street was once a family bakery.

Step 3 *Assessing your building in detail*

The existing shopfront bears no resemblance to the historic design and is inappropriate for the conservation area as it masks much of the building's heritage. These two shopfronts share details with their neighbour, 50 High Street, such as the historic oriel windows and shell details in the pediments.

The recommended approach...

A shopfront renewal that incorporates the modest amount of surviving architectural detail (notably, the shell pediments) on the shopfront is the best approach.



Existing shopfront 51-52 High Street

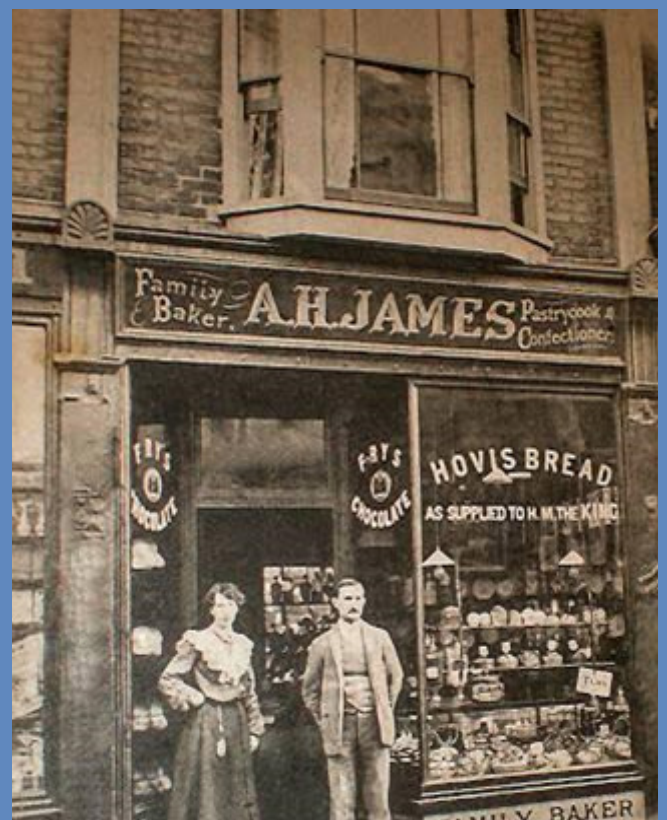

Historic photograph of 52 High Street



Example redesign of 51-52 High Street



Renewal

Upper storeys redesign:

On the upper floors the oriel windows are intact and mostly appear to be in a good condition. The PVC window frames should ideally be replaced with timber frames and made narrower to better match the historic window proportions. The pink paintwork should be repainted in a neutral cream or white.

Shopfront redesign:

51-52 Ryde High Street belong to the same building and the design of their shopfronts should reflect this. The existing signage is too large and not in the correct place. The shopfronts are in disrepair and do not relate to the historic features of the upper storeys. The new design is modelled on the original designs with some modifications on the glazing. Opening transom lights, for better ventilation give the units more flexibility to function as residential units.

5.3 Final Design Checklist

Below is a final checklist to use when assessing a proposed design for a commercial frontage in a conservation area. As a shopkeeper or landlord, you can ask yourself these questions before submitting a planning application, to gauge whether your design is on the right track. These points are covered earlier in the guide in greater detail.

- **Existing Streetscape:** does the proposed design feel consistent and complementary to the rest of the building and others adjoining it? Does the redesign consider the overall character of the immediate environment?
- **Shopfront design:** are there any historic shopfront details that can be retained and enhanced? Are there any historical photos which show the original shopfront design? Do the materials and design respond to the historical context? Is there evidence of the past building use in the design?
- **Building Elevations:** is the shopfront taking up a reasonable proportion of the building elevation? Are the window frames similar in design to the original window design? Do the upper storeys and shopfront complement each another?
- **Canopies and blinds:** have they been included within the overall design of the shopfront and the building as a whole? Are they appropriate for the use of the shop and within the streetscape?
- **Access:** are any enhancements needed to ensure that the design give access to all, including people with disabilities, in accordance with the Equality Act 2010? Is this integral to the design?
- **Security (if required):** are security devices obstructing any architectural features on the building? Do they look out of place with the rest of the elevation? Have internal sliding security grilles been considered?
- **Signage:** is the signage style, any advertisements, and illumination appropriate and in keeping with the shopfront, the building and streetscape?

★ CARD PAYMENT ONLY. ★
WELCOME
2 People only
IN SHOP
NO Groups.

Closed



Cakes & Pastries

PACKS



Cakes & Pastries



References

- 1 Boys Smith & Toms (2018), From NIMBY to YIMBY, p. 13. Underlying data from European Mortgage Federation. Eurostat.
- 2 The Commission into Prosperity and Community Placemaking (2021), No Place Left Behind



Newport & Carisbrooke
Community Council



ISLE of
WIGHT
COUNCIL



Historic England

